

Motor Protection Circuit Breaker and Motor Circuit Protector Specifications

Bulletin 140M

Topic	Page
Bulletin 140M Motor Protection Circuit Breakers	3
Overview	3
Catalog Number Explanation	5
Application Diagrams	6
Product Selection	8
Bulletin 140M Motor Circuit Protectors	11
Overview	11
Catalog Number Explanation	12
Application Diagrams	13
Product Selection	15

Topic	Page
Accessories	17
Specifications	25
Application Ratings	25
Definition of Type 2 Short Circuit Coordination:	31
IEC Performance Data	34
Cutoff Current	44
Time-Current Characteristic	49
Approximate Dimensions	51

Summary of Changes

This publication adds product selection and accessory information.

Additional Resources

These documents contain additional information concerning related products from Rockwell Automation.

Resource	Description
Use of Motor Protection Circuit Breakers with Variable-Frequency Drives, publication 140M-AT002	Provides application information about using 140M devices with variable-frequency drives.
Industrial Automation Wiring and Grounding Guidelines, publication 1770-4.1	Provides general guidelines for installing a Rockwell Automation industrial system.
Product Certifications website, https://www.rockwellautomation.com/global/certification/overview.page?	Provides declarations of conformity, certificates, and other certification details.

You can view or download publications at <http://www.rockwellautomation.com/global/literature-library/overview.page>. To order paper copies of technical documentation, contact your local Allen-Bradley distributor or Rockwell Automation sales representative.



Notes:

Bulletin 140M Motor Protection Circuit Breakers

Overview

Motor Protection Circuit Breakers may provide the following protective and control functions.

- Disconnect for Motor Branch Circuit
- Branch-Circuit, Short-Circuit Protection (Magnetic Protection)
- Overload Protection (Thermal Protection)
- Switching (Manual)

In North America, electrical codes require that an individual Motor Branch Circuit be protected by a UL/CSA Listed Fuse, Circuit Breaker or Self-Protected Combination Motor Controller.

140M-C, D, and F Frames

The 140M-C, D, and F frame Motor Protection Circuit Breakers may have two cULus Listings - as Manual, Self-Protected Combination Motor Controllers and as Manual Motor Controllers (with optional approvals for Motor Disconnect and Group Installation). Cat. No. 140M-D8V* can also be applied at the output of a variable frequency drive (VFD) in multi-motor applications. See [Application Conditions \(140M-D8V\) on page 41](#) for more information.

When UL/CSA listed as Manual, Self-Protected Combination Motor Controllers, the 140M Motor Protection Circuit Breakers provide all of the necessary NEC/CEC requirements for the protection and control of individual Motor Branch Circuits without additional protective devices.

At some higher voltages and currents (particularly at 600V), a few of the 140M-C, D, and F frame devices are only UL/CSA Listed as Manual Motor Controllers (with optional approvals for Motor Disconnect and Group Installation). In NEC/CEC Group Installations, these devices must be applied per the appropriate rules which require the use of an upstream Branch-Circuit, Short-Circuit Protective Device (BCPD).

Type E and Type F Combination Motor Controllers



Most of the 140M-C...F motor protection circuit breakers are UL Listed as a manual Type E self-protected combination motor controller. Although there are many tests involved, one of the critical tests a self-protected combination motor controller must pass, is to perform 6000 electrical operations and an additional 4000 mechanical operations after a short circuit.

By definition, a **Type F** combination motor controller consists of a Type E manual self protected combination motor controller and a magnetic or solid-state motor controller (such as a Bulletin 100-C contactor or an SMC). As with a manual Type E self-protected combination motor controller, additional short-circuit protection is not required for the individual motor circuits.

A combination of a Bulletin 140M manual self protected combination motor controller and 100-C contactor can be listed as a Type E self-protected combination motor controller. In this case, both the 140M and 100-C must pass the additional 6000 electrical and 4000 mechanical operational test. In some cases, this may require over sizing of the Bulletin 140M MPCB or the 100-C contactor to achieve weld free performance and meet the additional life requirements.

Standards Compliance and Certifications

Standards Compliance	Certifications
IEC/EN60947-1,-2,-4-1,-5-1	CE Marked
IEC/EN60204-1	CCC
CSA,C22.2 No.14	CSA Certified
UL508	cULus Listed (File No. E54612, NLRV(7); E205542, NKJH(7); E197878, DIVQ(7);)
	ATEX

			
	C-Frame	D-Frame	F-Frame
Max. Current I_e	32 A	32 A	45 A
Current Rating	0.1...32 A	1.6...32 A	6.3...45 A
Short Circuit Protection	✓	✓	✓
Standard Magnetic Trip	✓	✓	✓
High Magnetic Trip	✓	✓	✓
Magnetic Only Trip (MCP)	✓	✓	✓
Overload Protection	✓	✓	✓
Trip Class	10	10	10
Application at output of VFD (multi-motor)		✓ (140M-D8V)	
Standards Compliance			
CSA22.2, No.14	✓	✓	✓
UL508 (Group Installation)	✓ (see ratings)	✓ (see ratings)	✓ (see ratings)
UL508 Manual, Self Protected (Type E)	✓ (see ratings)	✓ (see ratings)	✓ (see ratings)
UL508 (Overload Protection)	✓	✓	✓
IEC60947-1,-2	✓	✓	✓
IEC60947-4-1	✓	✓	✓
CE	✓	✓	✓
ATEX (IEC60079-14)	✓ (up to 25 A)	✓ (up to 25 A; except 140M-D8V)	—
CCC	✓ (up to 25 A)	✓ (up to 25 A)	✓
Accessories			
External Rotary Operator	✓	✓	✓
Auxiliary Contacts	✓	✓	✓
Trip Indication Contacts	✓	✓	✓

Catalog Number Explanation

Examples given in this section are not intended to be used for product selection.

140M - C 2 E - A63 - KN - CC - GJ
 a b c d e f g h

a	
Bulletin Number	
Code	Description
140M	Motor Protection Circuit Breaker

b	
Frame/Rating	
Code	Description
C	32 A
D	32A
F	45A

c	
Interrupting Rating/Breaking Capacity	
Code	Description
2	Normal Break
8	High Break

d	
Protection Type	
Code	Description
E	Adj Thermal/ Fixed Mag(13 x I _n)
T	Adj Thermal/Fixed Mag (Fixed at 16...20 x I _n)
V	Adj Thermal/Fixed Mag application at output of VFD (multi-motor)

e		
Current Range		
Code	Description	Example
A	A=0.10	A16=0.16
B	B=1.0	B16=1.6
C	C=10	C16=16
D	D=100	D16=160
E	E=1000	E16=1600

f		
Miscellaneous		
Code	Description	Frame Size
KN	Black Lockable Knob	C,D,F
KRY	Red/Yellow Lockable Knob	C,D,F
TE	Spacing Adapter for Self-Protected Starters (Type E)	C,D,F
MT	STD BusBar Mount, Top	C,D,F

g			
Auxiliary Trip Contacts			
C, D, F Frames			
1st Code	Description	2nd Code	Description
Bottom Front		Right Side	
X	Placeholder	X	Placeholder
A	1 N.C.	C	1 N.O.+1 N.C.
B	1 N.O.	D	2 N.O.
C	1 N.O.+1 N.C.	E	2 N.C.
D	2N.O.	K	1 N.C. (SC+OL) + 1 N.C. (SC)
E	2N.C.	L	1 N.O. (SC+OL) + 1 N.O. (SC)
R	1 N.C.+ 1 N.O. (SC + OL)	M	1 N.C. (SC + OL)+ 1 N.O. (SC)
S	1 N.O.+1 N.O.(SC+OL)	N	1 N.O. (SC + OL) + 1 N.C. (SC)
		Q	1 N.O. (SC)+1 N.C.(SC)

h			
UV and Shunt Trips			
C, D, F Frame			
1st Code	Description	2nd Code	Description
Left Side		Voltage	
G	Undervoltage Trip	J	24V AC, 60 Hz
P	Shunt Trip	K	24V AC, 50 Hz
		D	120V AC, 60 Hz
		C	110V AC, 50 Hz
		H	208V AC, 60 Hz
		F	220...230V AC, 50 Hz
		A	240V AC, 60Hz
		T	277V AC, 60 Hz
		N	380...400V AC, 50 Hz
		B	480V AC, 60Hz and 415V AC, 50 Hz
		VC	600V AC, 60Hz
M	575V AC, 60Hz and 500V AC, 50 Hz		

Application Diagrams

Group Installation with MPCBs

There is only one Branch Circuit Protective Device (BCPD) for the “Group”.

Group installation has been successfully used for many years in the U.S. and Canada. It allows “two or motors or one or more motors and other loads to be connected to the same branch-circuit...”. The most restrictive part of the conditions specified for Group Installation is the requirement for the protection of the conductors for each motor circuit. In the U.S. NEC for 2002, a new rule for the conductor sizing was added for devices that are listed and marked “Suitable for use as Tap Conductor Protection”.

[Figure 1](#) shows an example that illustrates installations involving multiple motors with a single BCPD protecting the entire “Group”.

Bulletin 140M Motor Protection Circuit Breakers UL/CSA Listed for Group Installation: conductors from the BCPD to each motor must be a minimum of 1/3 the ampacity of the Branch Circuit conductors.

Bulletin 140M Motor Protection Circuit Breakers UL/CSA Listed for Tap conductor Protection in Group Installations: conductors from the BCPD to manual motor controller listed as “...Tap Conductor Protection...” must be minimum of 1/10 the rating or setting of the BCPD. Conductors from the controller to the motor must be 125% of the motor FLA.

Figure 1 - Group Installation with MPCBs

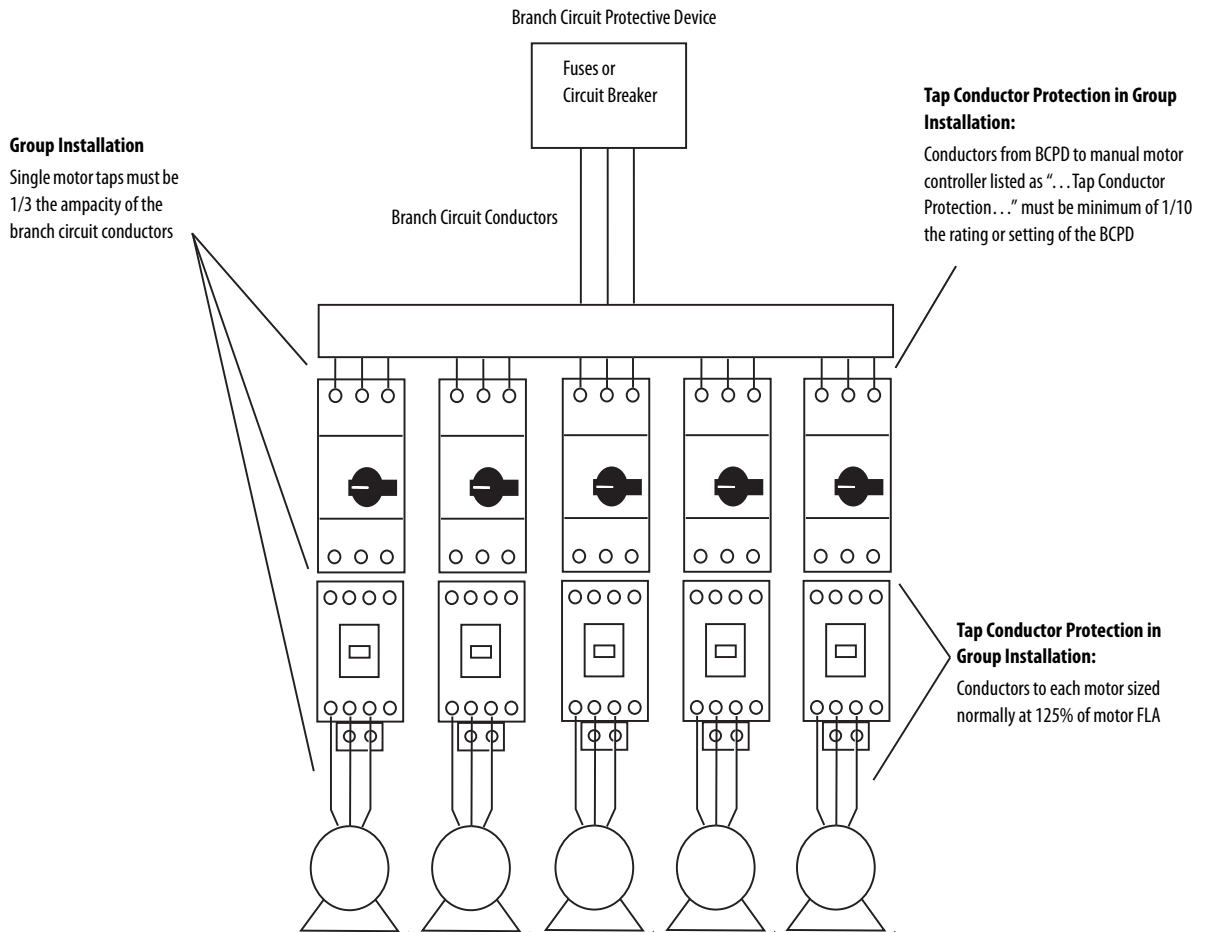

Multiple Motor Installation with MPCBs

Each Motor has an Individual Branch Circuit Protective Device.

Bulletin 140M Motor Protection Circuit Breakers (MPCBs) are UL/CSA Listed as **Type E Manual Self-Protected Combination Motor Controllers** or UL/CSA Listed as Circuit Breakers. These UL/CSA Listings allow the Bulletin 140M MPCBs to provide the branch-circuit, short-circuit protection (as well as overload protection) for each individual motor circuit. Additional short-circuit protection is not required for the protection of the individual motor circuits, leaving only the requirement for protection of the feeder circuit conductors by an upstream protective device. [Figure 2](#) shows an example that illustrates installations involving multiple motors, each with its own branch-circuit protection (BCPD).

Figure 2 - Multiple Motor Installation with MPCBs

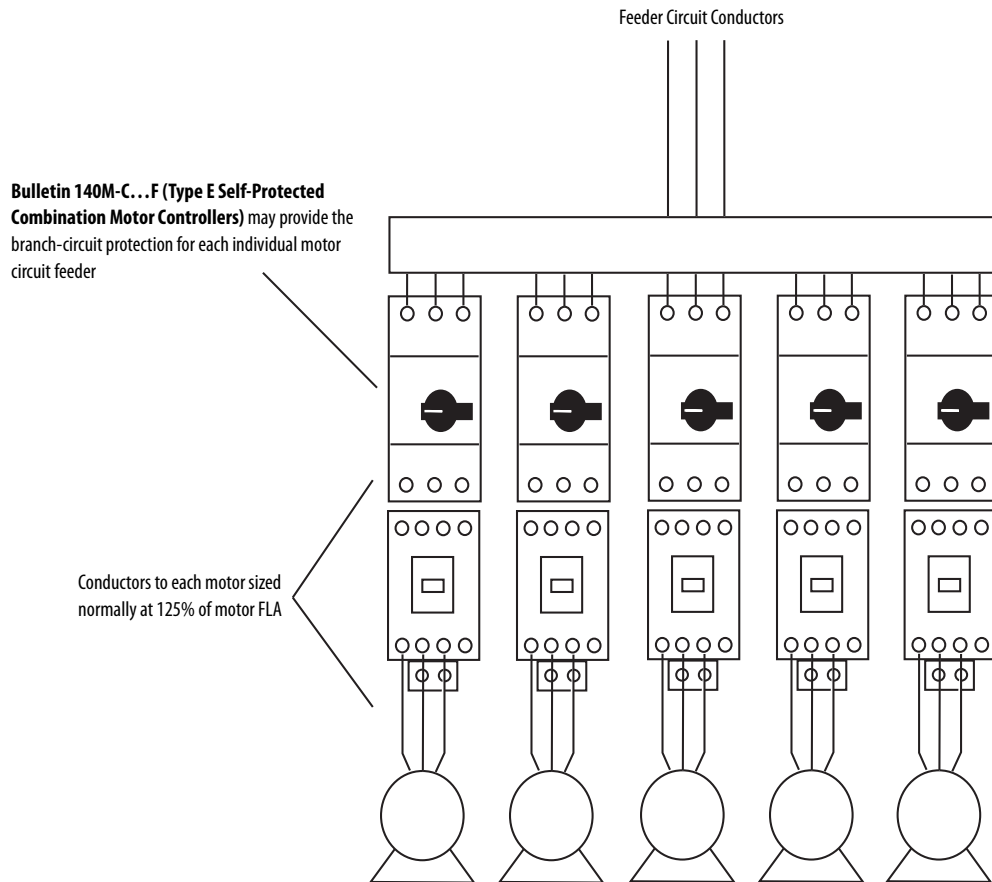

Product Selection



140M-C



140M-D



140M-F

Rated Operational Current (I_e) [A]	Motor Current Adjustment Range [A]	Magnetic Trip Current [A]	Max. Short Circuit Current [kA]		Max. 3-phase Hp Ratings ⁽¹⁾				Max. kW, 3-Phase — AC-3 ⁽¹⁾				Cat. No.
			400V (I_{cu})	480V (group motor)	200V	230V	460V	575V	230V	400/415V	500V	690V	
C-Frame													
0.16	0.10...0.16	2.1	100	65	—	—	—	—	—	0.02	0.06	0.06	140M-C2E-A16
0.25	0.16...0.25	3.3	100	65	—	—	—	—	—	0.04	0.09	0.09	140M-C2E-A25
0.4	0.25...0.40	5.2	100	65	—	—	—	0.25	0.06	0.09	0.12	0.18	140M-C2E-A40
0.63	0.40...0.63	8.2	100	65	—	—	0.25	0.33	0.09	0.18	0.18	0.25	140M-C2E-A63
1	0.63...1.0	13	100	65	—	—	0.5	0.75	0.18	0.25	0.37	0.55	140M-C2E-B10
1.6	1.0...1.6	21	100	65	0.25	0.33	1	1	0.25	0.55	0.75	1.1	140M-C2E-B16
2.5	1.6...2.5	33	100	65	0.5	0.75	1.5	2	0.37	0.75	1.1	1.8	140M-C2E-B25
4	2.5...4.0	52	100	65	1	1	3	3	0.75	1.5	2.2	3	140M-C2E-B40
6.3	4.0...6.3	82	100	65	1.5	2	5	5	1.5	2.2	3	4	140M-C2E-B63
10	6.3...10	130	100	65	3	3	7.5	10	2.2	4	6.3	7.5	140M-C2E-C10
16	10...16	208	65	30	5	5	10	15	4	7.5	10	13	140M-C2E-C16
20	14.5...20	260	50	30	5	7.5	15	20	5.5	10	11	17	140M-C2E-C20
25	18...25	325	15	25	7.5	7.5	20	20	5.5	11	15	22	140M-C2E-C25
29	24...29	406	15	25	7.5	10	20	25	7.5	13	18.5	25	140M-C2E-C29
32	27...32	448	15	25	7.5	10	25	30	7.5	15	20	25	140M-C2E-C32
D-Frame													
2.5	1.6...2.5	33	100	65	0.5	0.75	1.5	2	0.37	0.75	1.1	1.8	140M-D8E-B25
4	2.5...4.0	52	100	65	1	1	3	3	0.75	1.5	2.2	3	140M-D8E-B40
6.3	4.0...6.3	82	100	65	1.5	2	5	5	1.5	2.2	3	4	140M-D8E-B63
10	6.3...10	130	100	65	3	3	7.5	10	2.2	4	6.3	7.5	140M-D8E-C10
16	10...16	208	100	65	5	5	10	15	4	7.5	10	13	140M-D8E-C16
20	14.5...20	260	100	65	5	7.5	15	20	5.5	10	11	17	140M-D8E-C20
25	18...25	325	65	30	7.5	7.5	20	20	5.5	11	15	22	140M-D8E-C25
29	24...29	406	50	30	7.5	10	20	25	7.5	13	18.5	25	140M-D8E-C29
32	27...32	448	50	30	7.5	10	25	30	7.5	15	20	25	140M-D8E-C32
D-Frame, 140M-D8V...													
1.6	1.0...1.6	82	65	65	0.25	0.33	1	—	0.25	0.55	0.75	—	140M-D8V-B16
2.5	1.6...2.5	82	65	65	0.5	0.75	1.5	—	0.37	0.75	1.1	—	140M-D8V-B25
4	2.5...4.0	82	65	65	1	1	3	—	0.75	1.5	2.2	—	140M-D8V-B40
6.3	4.0...6.3	82	65	65	1.5	2	5	—	1.5	2.2	3	—	140M-D8V-B63
10	6.3...10	130	65	65	3	3	7.5	—	2.2	4	6.3	—	140M-D8V-C10
16	10...16	208	65	65	5	5	10	—	4	7.5	10	—	140M-D8V-C16
20	14.5...20	260	65	65	5	7.5	15	—	5.5	10	11	—	140M-D8V-C20
25	18...25	325	65	30	7.5	7.5	20	—	5.5	11	15	—	140M-D8V-C25
29	24...29	406	50	30	7.5	10	20	—	7.5	13	18.5	—	140M-D8V-C29
32	27...32	448	50	30	7.5	10	25	—	7.5	15	20	—	140M-D8V-C32

Rated Operational Current (I_e) [A]	Motor Current Adjustment Range [A]	Magnetic Trip Current [A]	Max. Short Circuit Current [kA]		Max. 3-phase Hp Ratings ⁽¹⁾				Max. kW, 3-Phase — AC-3 ⁽¹⁾				Cat. No.
			400V (I_{cu})	480V (group motor)	200V	230V	460V	575V	230V	400/415V	500V	690V	
F-Frame													
10	6.3...10	130	100	65	3	3	7.5	10	2.2	4	6.3	7.5	140M-F8E-C10
16	10...16	208	100	65	5	5	10	15	4	7.5	10	13	140M-F8E-C16
20	14.5...20	260	100	65	5	7.5	15	20	5.5	10	11	17	140M-F8E-C20
25	18...25	325	100	65	7.5	10	20	25	6.3	11	15	22	140M-F8E-C25
32	23...32	416	65	65	7.5	10	25	30	7.5	15	20	30	140M-F8E-C32
45	32...45	585	65	65	10	15	30	40	13	22	30	40	140M-F8E-C45

(1) Horsepower/kW ratings show are for reference. The final selection of the MPCB depends on the actual motor full load current.

High Inrush Motor Protection Circuit Breakers

- Short-circuit Protection — High Magnetic Trip (Fixed at 16...21 x I_e)
- Overload Protection — Trip Class 10



Rated Operational Current (I_e) [A]	Motor Current Adjustment Range [A]	Magnetic Trip Current [A]	Max. Short Circuit Current [kA]		Max. 3-phase Hp Ratings ⁽¹⁾				Max. kW, 3-Phase — AC-3 ⁽¹⁾				Cat. No.
			400V (I_{cu})	480V (group motor)	200V	230V	460V	575V	230V	400/415V	500V	690V	
C-Frame													
0.16	0.10...0.16	3.3	100	65	—	—	—	—	—	0.02	0.06	0.06	140M-C2T-A16
0.25	0.16...0.25	5.2	100	65	—	—	—	—	—	0.04	0.09	0.09	140M-C2T-A25
0.4	0.25...0.40	8.2	100	65	—	—	—	0.25	0.06	0.09	0.12	0.18	140M-C2T-A40
0.63	0.40...0.63	13	100	65	—	—	0.25	0.33	0.09	0.18	0.18	0.25	140M-C2T-A63
1	0.63...1.0	21	100	65	—	—	0.5	0.75	0.18	0.25	0.37	0.55	140M-C2T-B10
1.6	1.0...1.6	33	100	65	0.25	0.33	1	1	0.25	0.55	0.75	1.1	140M-C2T-B16
2.5	1.6...2.5	52	100	65	0.5	0.75	1.5	2	0.37	0.75	1.1	1.8	140M-C2T-B25
4	2.5...4	82	100	65	1	1	3	3	0.75	1.5	2.2	3	140M-C2T-B40
6.3	4...6.3	130	100	65	1.5	2	5	5	1.5	2.2	3	4	140M-C2T-B63
10	6.3...10	208	100	30	3	3	7.5	10	2.2	4	6.3	7.5	140M-C2T-C10
16	10...16	260	50	30	5	5	10	15	4	7.5	10	13	140M-C2T-C16
D-Frame													
16	10...16	260	100	65	5	5	10	15	4	7.5	10	13	140M-D8T-C16
20	14.5...20	325	65	30	5	7.5	15	20	5.5	10	11	17	140M-D8T-C20
F-Frame													
25	18...25	416	65	65	7.5	10	20	25	6.3	11	15	22	140M-F8T-C25
32	23...32	585	65	65	7.5	10	25	30	7.5	15	20	30	140M-F8T-C32

(1) Horsepower/kW ratings show are for reference. The final selection of the MPCB depends on the actual motor full load current.

Screwless Motor Protection Circuit Breakers

- Short-circuit Protection — High Magnetic Trip (Fixed at $16...21 \times I_c$)
- Overload Protection — Trip Class 10



140M-RC2

Rated Operational Current (I_c) [A]	Motor Current Adjustment Range [A]	Magnetic Trip Current [A]	Max. Short Circuit Current [kA]		Max. 3-phase Hp Ratings ⁽¹⁾				Max. kW, 3-Phase — AC-3 ⁽¹⁾				Cat. No.
			400V (I_{cu})	480V (group motor)	200V	230V	460V	575V	230V	400/415V	500V	690V	
C-Frame													
0.16	0.10...0.16	2.1	100	65	—	—	—	—	—	0.02	0.06	0.06	140M-RC2E-A16
0.25	0.16...0.25	3.3	100	65	—	—	—	—	—	0.04	0.09	0.09	140M-RC2E-A25
0.4	0.25...0.40	5.2	100	65	—	—	—	0.25	0.06	0.09	0.12	0.18	140M-RC2E-A40
0.63	0.40...0.63	8.2	100	65	—	—	0.25	0.33	0.09	0.18	0.18	0.25	140M-RC2E-A63
1	0.63...1.0	13	100	65	—	—	0.5	0.75	0.18	0.25	0.37	0.55	140M-RC2E-B10
1.6	1.0...1.6	21	100	65	0.25	0.33	1	1	0.25	0.55	0.75	1.1	140M-RC2E-B16
2.5	1.6...2.5	33	100	65	0.5	0.75	1.5	2	0.37	0.75	1.1	1.8	140M-RC2E-B25
4	2.5...4.0	52	100	65	1	1	3	3	0.75	1.5	2.2	3.0	140M-RC2E-B40
6.3	4.0...6.3	82	100	65	1.5	2	5	5	1.5	2.2	3.0	4.0	140M-RC2E-B63
10	6.3...10	130	100	65	3	3	7.5	10	2.2	4.0	6.3	7.5	140M-RC2E-C10
16	10...16	208	65	30	5	5	10	15	4.0	7.5	10	13	140M-RC2E-C16

(1) Horsepower/kW ratings show are for reference. The final selection of the MPCB depends on the actual motor full load current.

Bulletin 140M Motor Circuit Protectors

Overview

Motor Circuit Protectors (MCPs) may provide the following protective and control functions.

- Disconnect for Motor Branch Circuit
- Branch-Circuit, Short-Circuit Protection (Magnetic Protection)
- Switching (Manual)

In North America, electrical codes require that an individual Motor Branch Circuit be protected by a UL/CSA Listed Fuse, Circuit Breaker or Self-Protected Combination Motor Controller.



140M-C, D, and F Frames:

The 140M-C, D and F frame Motor Circuit Protectors have one UL/CSA Listing - as Manual Motor Controllers (with optional approvals for Motor Disconnect and Group Installation). In NEC/CEC Group Installations, these devices must be applied per the appropriate rules, which require the use of an upstream Branch-Circuit, Short-Circuit Protective Device (BCPD).

The 140M-C, D and F Frame Motor Circuit Protectors are also UL/CSA Listed, together with a Bulletin 100C contactor and Bulletin 193 overload relay, as part of our Bulletin 103T and 107T Self-Protected IEC Combination Starters. These starters are then able to provide all of the necessary NEC/CEC requirements for the protection and control of individual Motor Branch Circuits without additional protective devices.

Standards Compliance and Certifications

Standards Compliance	Certifications
IEC/EN60947-1,-2,-4-1,-5-1	CE Marked
IEC/EN60204-1	CCC
CSA,C22.2 No.14	cULus Listed (File No. E54612, Guide No. NLRV, NLRV7)
UL508	

			
	C-Frame	D-Frame	F-Frame
Current Rating	0.16...2.5 A	2.5...32 A	25...45 A
Short Circuit Protection	✓	✓	✓
Standards Compliance:			
CSA22.2, No.14	✓	✓	✓
UL508 (Group Installation)	✓	✓	✓
IEC60947-2	✓	✓	✓
CE	✓	✓	✓
CCC	✓	✓ (up to 25 A)	✓
Accessories			
External Rotary Operator	✓	✓	✓
Auxiliary Contacts	✓	✓	✓
Trip Indication Contacts	✓	✓	✓

Catalog Number Explanation

Examples in this section are not intended to be used for product selection.

140M - **C 2 N** - **A63** - **KN** - **CC** - **GJ**
 a b c d e f g h

a	
Bulletin Number	
Code	Description
140M	Motor Circuit Protector

b	
Frame/Rating	
Code	Description
C	25 A
D	32A
F	45A

c	
Interrupting Rating/Breaking Capacity	
Code	Description
2	Normal Break
8	High Break

d	
Protection Type	
Code	Description
N	Fixed Mag only (13 x I _n)

e		
Current Range		
Code	Description	Example
A	A=0.10	A16=0.16
B	B=1.0	B16=1.6
C	C=10	C16=16
D	D=100	D16=160
E	E=1000	E16=1600

f		
Miscellaneous		
Code	Description	Frame Size
KN	Black Lockable Knob	C,D,F
KRY	Red/Yellow Lockable Knob	C,D,F
TE	Spacing Adapter for Self-Protected Starters (Type E)	C,D,F
MT	STD BusBar Mount, Top	C,D,F

g			
Auxiliary Trip Contacts			
C, D, F Frames			
1st Code	Description	2nd Code	Description
Bottom Front		Right Side	
X	Placeholder	X	Placeholder
A	1 N.C.	C	1 N.O.+1 N.C.
B	1 N.O.	D	2 N.O.
C	1 N.O.+1 N.C.	E	2 N.C.
D	2N.O.	K	1 N.C. (SC+OL) + 1 N.C. (SC)
E	2N.C.	L	1 N.O. (SC+OL) + 1 N.O. (SC)
R	1 N.C.+ 1 N.O. (SC + OL)	M	1 N.C. (SC + OL) + 1 N.O. (SC)
S	1 N.O.+1 N.O.(SC+OL)	N	1 N.O. (SC + OL) + 1 N.C. (SC)
		Q	1 N.O. (SC)+1 N.C.(SC)

h			
UV and Shunt Trips			
C, D, F Frame			
1st Code	Description	2nd Code	Description
Left Side		Voltage	
G	Undervoltage Trip	J	24V AC, 60 Hz
P	Shunt Trip	K	24V AC, 50 Hz
		D	120V AC, 60 Hz
		C	110V AC, 50 Hz
		H	208V AC, 60 Hz
		F	220...230V AC, 50 Hz
		A	240V AC, 60Hz
		T	277V AC, 60 Hz
		N	380...400V AC, 50 Hz
		B	480V AC, 60Hz and 415V AC, 50 Hz
		VC	600V AC, 60Hz
		M	575V AC, 60Hz and 500V AC, 50 Hz

Application Diagrams

Group Installation with MCPs

There is only one Branch Circuit Protective Device (BCPD) for the “Group”.

Group installation has been successfully used for many years in the U.S. and Canada. It allows “two or motors or one or more motors and other loads to be connected to the same branch-circuit...”. The most restrictive part of the conditions specified for Group Installation is the requirement for the protection of the conductors for each motor circuit.

[Figure 3](#) shows an example that illustrates installations involving multiple motors with a single BCPD protecting the entire “Group”.

Bulletin 140M Motor Circuit Protectors UL/CSA Listed for Group Installation: conductors from the BCPD to each motor must be a minimum of 1/3 the ampacity of the Branch Circuit conductors. MCPs do not provide thermal protection, so a separate overload relay must be used. Because of this, MCPs cannot be UL/CSA Listed for Tap Conductor Protection in group installations.

Figure 3 - Group Installation with MCPs

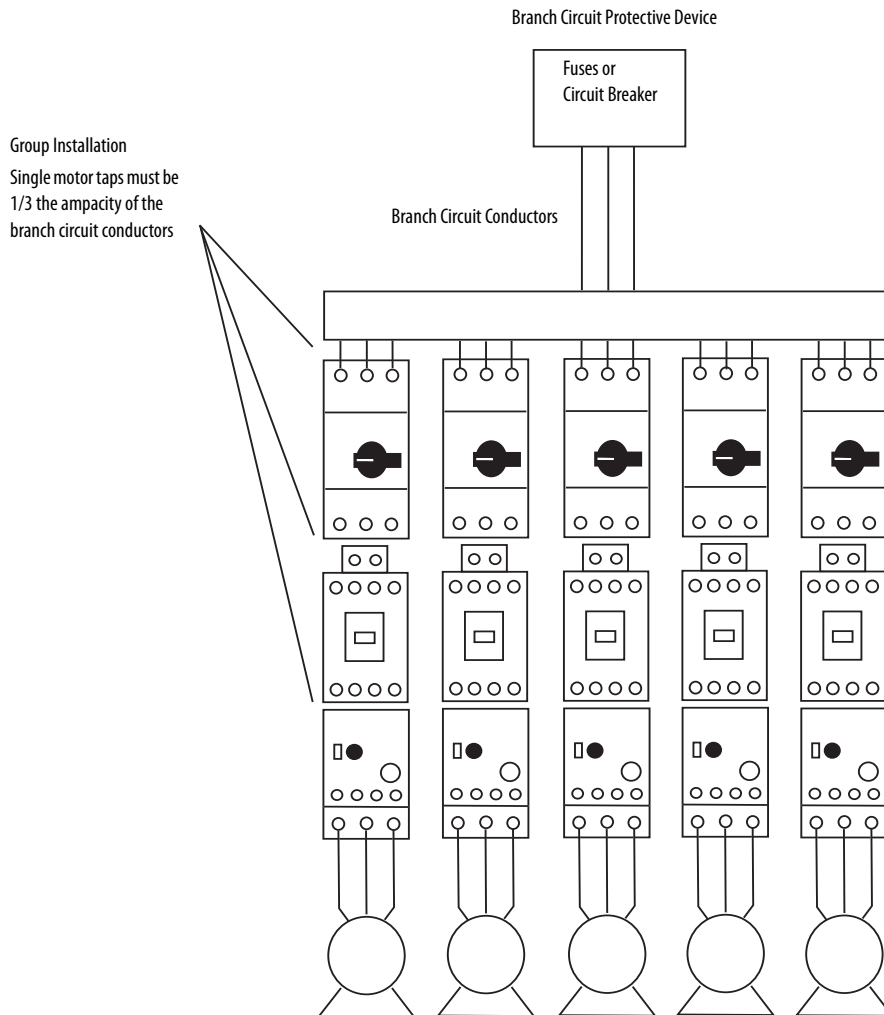

Multiple Motor Installation with MCPs

Each Motor has an Individual Branch Circuit Protective Device.

Bulletin 140M Motor Circuit Protectors (MCPs) are UL/CSA Listed as part of a Combination Motor Controllers or a Self-Protected Combination Motor Controller consisting of a 140M Motor Circuit Protector, a 100-C Contactor, and a 193 Overload Relay. These UL/CSA Listings allow the Bulletin 140M MCPs to provide the branch-circuit, short-circuit protection for each individual motor circuit. Additional short-circuit protection is not required for the protection of the individual motor circuits, leaving only the requirement for protection of the feeder circuit conductors by an upstream protective device. [Figure 4](#) shows an example that illustrates installations involving multiple motors, each with its own branch-circuit protection (BCPD).

Figure 4 - Multiple Motor Installation with MCPs

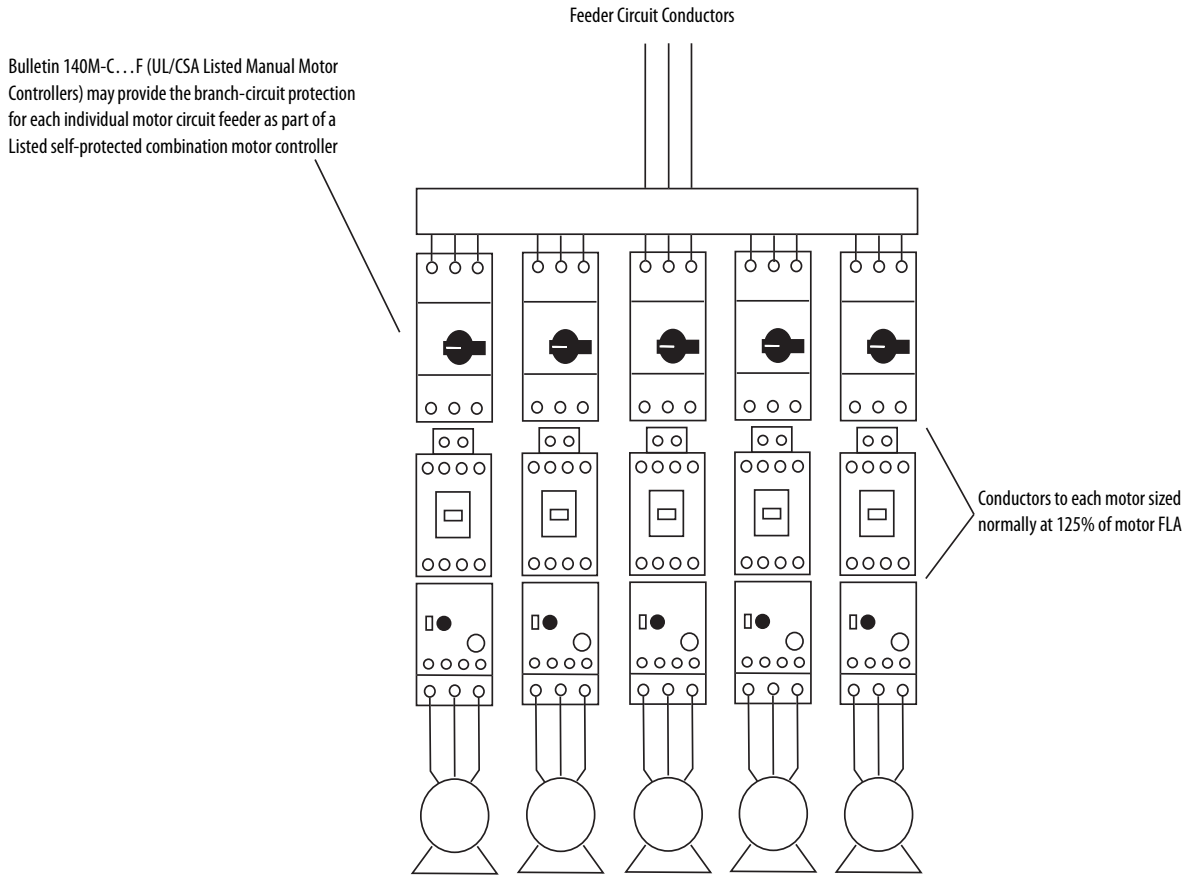

Product Selection

- For trip Class 10 motor applications



140M-C



140M-D



140M-F

Rated Operational Current (I_e) [A] ⁽¹⁾	Magnetic Trip Current [A]	Ultimate Interrupting Current [kA]		Max. 3-phase Hp Ratings ⁽²⁾				Max. kW, 3-Phase — AC-3 ⁽²⁾				Cat. No.
		400V (I_{cu})	480V (group motor)	200V	230V	460V	575V	230V	400/415V	500V	690V	
C-Frame												
0.16	2.1	100	65	—	—	—	—	—	0.02	0.06	0.06	140M-C2N-A16
0.25	3.3	100	65	—	—	—	—	—	0.04	0.09	0.09	140M-C2N-A25
0.4	5.2	100	65	—	—	—	0.25	0.06	0.09	0.12	0.18	140M-C2N-A40
0.63	8.2	100	65	—	—	0.25	0.33	0.09	0.18	0.18	0.25	140M-C2N-A63
1	13	100	65	—	—	0.5	0.75	0.18	0.25	0.37	0.55	140M-C2N-B10
1.6	21	100	65	0.25	0.33	1	1	0.25	0.55	0.75	1.1	140M-C2N-B16
2.5	33	100	65	0.5	0.75	1.5	2	0.37	0.75	1.1	1.8	140M-C2N-B25
D-Frame												
2.5	33	100	65	0.5	0.75	1.5	2	0.37	0.75	1.1	1.8	140M-D8N-B25
4	52	100	65	1	1	3	3	0.75	1.5	2.2	3	140M-D8N-B40
6.3	82	100	65	1.5	2	5	5	1.5	2.2	3	4	140M-D8N-B63
10	130	100	65	3	3	7.5	10	2.2	4	6.3	7.5	140M-D8N-C10
16	208	100	65	5	5	10	15	4	7.5	10	13	140M-D8N-C16
25	325	65	30	7.5	7.5	20	20	5.5	11	15	22	140M-D8N-C25
32	448	50	30	7.5	10	25	30	7.5	15	20	25	140M-D8N-C32
F-Frame												
25	325	100	65	7.5	10	20	25	6.3	11	15	22	140M-F8N-C25
32	416	65	65	7.5	10	25	30	7.5	15	20	30	140M-F8N-C32
45	585	65	65	10	15	30	40	13	22	30	40	140M-F8N-C45

(1) In applications with 140M-C_N, 140M-D_N and 140M-F_N as the short circuit protection device of heavy duty starting motors, the rated operational current I_e of the above devices must be over-dimensioned with following factors:



Class 10 = 1.00
 Class 15 = 1.22
 Class 20 = 1.42
 Class 25 = 1.58
 Class 30 = 1.73

(2) Horsepower/kW ratings show are for reference. The final selection of the MCP depends on the actual motor full load current.

Notes:

Accessories

Auxiliary Contacts







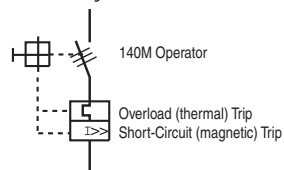

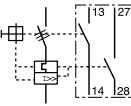
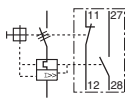
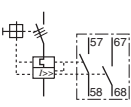

Description	Operator Position ⁽¹⁾			Term. No.	Contact Description	Connection Diagram ⁽²⁾	For Use With	Cat. No.
	OFF	ON	Tripped					
 Front-Mounted Auxiliary Contact <ul style="list-style-type: none"> • 1-pole or 2-pole • No additional space required • Only one per device 	0	X	0	13-14	N.O. Aux		140M-C, D, F; 140U-D (UL489) only in combination with 140M-C-AFC	140M-C-AFA10
	X	0	X	11-12	N.C. Aux			140M-C-AFA01
 Right Side-Mounted Auxiliary Contact <ul style="list-style-type: none"> • 2-pole • Adds 9 mm to the width of the device • Two per device 	0	X	0	13-14	N.O. Aux		140M-C, D, F; 140U-D (UL489) only in combination with 140M-C-AFC	140M-C-AFA11
	X	0	X	21-22	N.C. Aux			140M-C-AFA20
	0	X	0	13-14	N.O. Aux			140M-C-AFA02
	0	X	0	23-24	N.O. Aux			
	X	0	X	11-12	N.C. Aux			
	X	0	X	21-22	N.C. Aux			
 Right Side-Mounted Auxiliary Contact <ul style="list-style-type: none"> • 2-pole • Adds 9 mm to the width of the device • Two per device 	0	X	0	33-34	N.O. Aux		140M-C, D, F	140M-C-ASA20
	0	X	0	43-44	N.O. Aux			
	X	0	X	31-32	N.C. Aux		140M-C, D, F	140M-C-ASA02
	X	0	X	41-42	N.C. Aux			
	0	X	0	33-34	N.O. Aux		140M-C, D, F	140M-C-ASA11
	X	0	X	41-42	N.C. Aux			

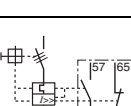
(1) X = Contact Closed; 0 = Contact Open

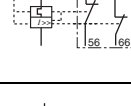
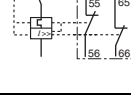
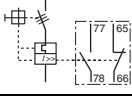
(2) Connection Diagram Reference:



Trip Contacts



Description	Operator Position ⁽¹⁾			Term. No.	Contact Description	Connection Diagram ⁽²⁾	For Use With	Cat. No.
	OFF	ON	Tripped					
 <p>Front-Mounted Trip Contact</p> <ul style="list-style-type: none"> • 2-pole • Indicates tripping of device • No additional space required 	0	X	0	13-14	N.O. Aux		140M-C, D, F; 140U-D (UL489 only in combination with 140M-C-AFC)	140M-C-AFAR10A10
	0	0	X	27-28	N.O. Trip (short-circuit and overload)			
	X	0	X	11-12	N.C. Aux		140M-C, D, F	
	0	0	X	27-28	N.O. Trip (short-circuit and overload)			
 <p>Right-Side Mounted Trip Contact</p> <ul style="list-style-type: none"> • 2-pole • Indicates tripping of the device • Adds 9 mm to the width of the device • One only per device • A right-side mounted auxiliary contact may be tandem mounted on top of this trip contact 	0	0	X	57-58	N.O. Trip (short-circuit and overload)		140M-C, D, F	
	0	0	X	67-68	N.O. Trip (short-circuit)			
	0	0	X	57-58	N.O. Trip (short-circuit and overload)		140M-C, D, F	
	X	X	0	65-66	N.C. Trip (short-circuit)			
	X	X	0	55-56	N.C. Trip (short-circuit and overload)		140M-C, D, F	
	0	0	X	67-68	N.O. Trip (short-circuit)			
	X	X	0	55-56	N.C. Trip (short-circuit and overload)		140M-C, D, F	
	X	X	0	65-66	N.C. Trip (short-circuit)			
	0	0	X	77-78	N.O. Trip (short-circuit)		140M-C, D, F	
X	X	0	65-66	N.C. Trip (short-circuit)				140M-C, D, F

(1) X = Contact Closed; 0 = Contact Open

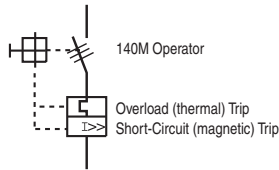
(2) Connection Diagram Reference:



Auxiliary and Trip Contacts



Description	Operator Position ⁽¹⁾			Term. No.	Contact Description	Connection Diagram ⁽²⁾	For Use With	Cat. No.
	OFF	ON	Tripped					
 <p>Front-Mounted Auxiliary Contact</p> <ul style="list-style-type: none"> • 1-pole or 2-pole • No additional space required • - Only 1 per device 	0	X	0	13-14	N.O. Aux		140M-C, D, F; 140M-RC	140M-RC-AFA10
	X	0	X	11-12	N.C. Aux			140M-RC-AFA01
	0	X	0	13-14	N.O. Aux		140M-C, D, F; 140M-RC	140M-RC-AFA11
	X	0	X	21-22	N.C. Aux			140M-RC-AFA11
	0	X	0	13-14	N.O. Aux			140M-RC-AFA20
	0	X	0	23-24	N.O. Aux			140M-RC-AFA20
 <p>Front-Mounted Trip Contact</p> <ul style="list-style-type: none"> • 2-pole • Indicates tripping of device • No additional space required 	0	X	0	13-14	N.O. Aux		140M-C, D, F; 140M-RC	140M-RC-AFAR10A01
	0	0	X	27-28	N.O. Trip (short-circuit and overload)			140M-RC-AFAR10A01
	X	0	X	11-12	N.C. Aux		140M-RC-AFAR10A10	140M-RC-AFAR10A10
	0	0	X	27-28	N.O. Trip (short-circuit and overload)			140M-RC-AFAR10A10

(1) X = Contact Closed; 0 = Contact Open

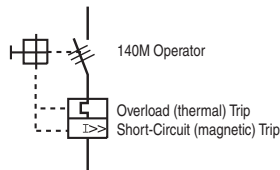
(2) Connection Diagram Reference:



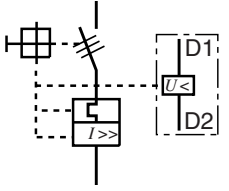

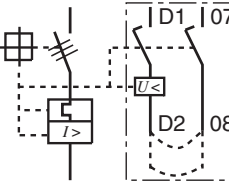
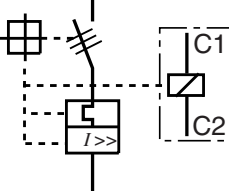



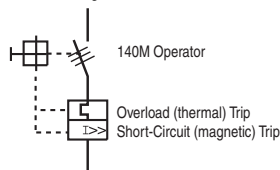

Undervoltage and Shunt Trip Units



Description	Connection Diagram ⁽¹⁾	Trip Rating	For Use With	Cat. No.
Undervoltage Trip <ul style="list-style-type: none"> • Left-side mounted • Adds 18 mm to the width of the device • Automatically trips MPCB/MCP when voltage falls below 35...70% 		24V, 60 Hz	140M-C, D, F; 140U-D	140M-C-UXJ
		24V, 50 Hz		140M-C-UXK
		120V, 60 Hz		140M-C-UXD
		110V, 50 Hz		140M-C-UXC
		208V, 60 Hz		140M-C-UXH
		220...230V, 50 Hz		140M-C-UXF
		240...260V, 60 Hz		140M-C-UXA
		277V, 60 Hz		140M-C-UXT
		380...400V, 50 Hz		140M-C-UXN
		480V, 60 Hz/415V, 50 Hz		140M-C-UXB
		575V, 60 Hz/500V, 50 Hz		140M-C-UXM
		600V, 60 Hz		140M-C-UXVC
		 Undervoltage Trip <ul style="list-style-type: none"> • Left-side mounted • 2 early make contacts integrated • Adds 18 mm to the width of the device • Automatically trips MPCB/MCP when voltage falls below 35...70% 		
24V, 50 Hz	140M-C-UCK			
120V, 60 Hz	140M-C-UCD			
110V, 50 Hz	140M-C-UCC			
208V, 60 Hz	140M-C-UCH			
220...230V, 50 Hz	140M-C-UCF			
240...260V, 60 Hz	140M-C-UCA			
277V, 60 Hz	140M-C-UCT			
380...400V, 50 Hz	140M-C-UCN			
480V, 60 Hz/415V, 50 Hz	140M-C-UCB			
575V, 60 Hz/500V, 50 Hz	140M-C-UCM			
600V, 60 Hz	140M-C-UCVC			
Shunt Trip <ul style="list-style-type: none"> • Left-side mounted • Adds 18 mm to the width of the device • Provides remote tripping of the MPCB/MCP • Maximum on time for DC operated devices: 5 sec. 			24V, 60 Hz	
		24V, 50 Hz	140M-C-SNK	
		110V, 50 Hz/120V, 60 Hz	140M-C-SND	
		208V, 60 Hz	140M-C-SNH	
		220...230V, 50 Hz	140M-C-SNF	
		240...260V, 60 Hz	140M-C-SNA	
		277V, 60 Hz	140M-C-SNT	
		380...400V, 50 Hz	140M-C-SNN	
		480V, 60 Hz/415V, 50 Hz	140M-C-SNB	
		575V, 60 Hz/500V, 50 Hz	140M-C-SNM	
		600V, 60 Hz	140M-C-SNVC	
		24V DC	140M-C-SNZJ	



(1) Connection Diagram Reference:

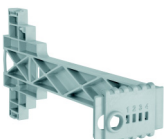

Additional Accessories

	Description	For Use With	Cat. No.
	<p>Anti-Tamper Shield</p> <ul style="list-style-type: none"> Provides protection against inadvertent adjustment of the current setting Must be ordered in multiples of 10 (10 pcs/pkg) 	140M-C, D, F	140M-C-CA
	<p>Lockable Twist Knob</p> <ul style="list-style-type: none"> For one padlock 5 mm (3/16 in.) diameter shackle Can be locked in OFF position 	Black	140M-C-KN1
		Red/Yellow	140M-C, D, F 140U- D
	<p>Locking Tag</p> <ul style="list-style-type: none"> Padlock attachment to the lockable handles Up to three padlocks 4. . . 8 mm (5/16 in.) diameter shackle 	140M-C-KN1 140M- C-KRY1	140M-C-M3
	<p>Door Coupling Handle</p> <ul style="list-style-type: none"> For 3 padlocks 4. . . 8 mm (5/16 in.) in diameter IP66 Protection/Type 1, 4, 4X, 12 Interlock override capability Can be modified for locking in ON position Ships with coupling — order extension shaft and legend plate separately Mounting depth (front of DIN Rail to front of enclosure door): 140M-C: 105.5 mm ± 5 mm (4.15 in. ± 3/16 in.) 140M-D: 114.5 mm ± 5 mm (4.5 in. ± 3/16 in.) 140M-F: 137.1 mm ± 5 mm (5.4 in. ± 3/16 in.) 140U-D: 114.5mm ± 5mm (4.5 in. ±3/16 in.) ser E or later handles only 	Black	140M-C-DN66
		Red/Yellow	140M-C, D, F 140U- D
	<p>Extension Shaft</p> <ul style="list-style-type: none"> Cut to required length for mounting depth (front of DIN Rail to front of enclosure door): 140M-C: 117. . . 338 mm (4.6. . . 13.3 in.) 140M-D: 126. . . 347 mm (5.0. . . 13.7 in.) 140M-F: 149. . . 369 mm (5.9. . . 14.5 in.) 140U-D: 126. . . 347 mm (5.0. . . 13.7 in.) ser E or later handles only 	140M-C-DN66, 140M-C-DRY66,	140M-C-DS
			<p>Extension Shaft (Extended Length)</p> <ul style="list-style-type: none"> Cut to required length for mounting depth (front of DIN Rail to front of enclosure door): 140M-C: 117. . . 488 mm (4.6. . . 19.2 in.) 140M-D: 126. . . 497 mm (5.0. . . 19.6 in.) 140M-F: 149. . . 519 mm (5.9. . . 20.4 in.) 140U-D: 126. . . 497 mm (5.0. . . 19.6 in.) ser E or later handles only
	<p>Door Coupling Handle</p> <ul style="list-style-type: none"> Type 3, 3R, 4, 4X, 12 (IP66) For up to 2 padlocks Fits in 30.5 mm cutout Requires 140M-C-DNC coupler 	Black	140M-SB
		Red/Yellow	140M-C, D, F 140U- D
	<p>Extension Shaft</p> <ul style="list-style-type: none"> Cut to required length for mounting depth (front of DIN Rail to front of enclosure door) 	12 in. (30.48 cm)	140M-S1
		21 in. (53.34 cm)	140M-SB, 140M-SY
	<p>Coupler</p> <ul style="list-style-type: none"> Included with Cat. Nos. 140M-C-DN66 and 140M-C-DRY66 	140M-C, D, F 140U- D	140M-C-DNC
	<p>Extension Shaft Support</p> <ul style="list-style-type: none"> Provides consistent alignment of the 140M-C-DS and 140M-C-DSL shafts with the 140M-C-DN66 or 140M-C-DRY66 door coupling handles. It is recommended for shaft lengths >200 mm. Snaps on the right side of the 140M-C, -D, -F or 140U-D and allows for the addition of one side-mounted auxiliary contact. Width 9 mm. For use with screw-mounted or hat rail mounted devices. 	140M-C, D, F 140U- D	140M-C-SHS

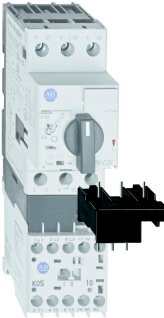
	Description	For Use With	Cat. No.
	Legend Plate	Marking: "Hauptschalter" and "Main Switch"	140-CDN66 140M-C-DFCN
		Marking: "Not-Aus" and "Emergency Off"	140-CDRY66 140M-C-DFCRY
	IP65 Non-Metallic Enclosure <ul style="list-style-type: none"> • Knockouts for M20 and M25 fittings • Suitable for flexible cable with internal ground wire or conduit when externally grounded around the outside of the enclosure (no UL/CSA approval) 	Black Handle	140M-C 198E-AYTG2
		Red/Yellow Handle	140M-C 198E-AYTJ2
	Screw Adapter <ul style="list-style-type: none"> • For screw arrangement of a motor protection circuit breaker • Must be ordered in multiples of 10 (10 pcs/pkg) 	140M-C, D, F 140U- D	140M-C-N45

	Description	For Use With	Cat. No.
	ECO Connecting Module — 12 A <ul style="list-style-type: none"> • For DOL and reversing starters • Eco-starters mount on single DIN Rail (140M on DIN Rail) • Electrical and mechanical interconnection of 140M and 100-K contactors 	140M-C to 100-K	140M-C-PEK12
	ECO Connecting Modules — 25 A <ul style="list-style-type: none"> • Eco-starters mount on single DIN Rail (140M on DIN Rail) • Electrical and mechanical interconnection of 140M MPCB and 100-C (with AC coils or 24V DC electronic coils) contactors 	140M-C to 100-C09...C23	140M-C-PEC23
		140M-D to 100-C09...C23	140M-D-PEC23
	ECO Connecting Modules — 25 A <ul style="list-style-type: none"> • Eco-starters mount on single DIN Rail (100-C on DIN Rail) • Electrical and mechanical interconnection of 140M MPCB and 100-C (with conventional DC coils) 	140M-C, 140M-D to 100-C09...C23	140M-C-PEC23A
	Connecting Modules — 25 and 45 A <ul style="list-style-type: none"> • Contactor and MPCB MUST BE mounted separately on (2) DIN Rails Electrical interconnection of 140M and 100-C (with AC coils) 	140M-C to 100-C09...C23	140M-C-PNC23
		140M-D to 100-C09...C23	140M-D-PNC23
		140M-D to 100-C30...C37	140M-D-PNC37
140M-F to 100-C30...C37		140M-F-PNC37	
Coil Modules — 25 A and 45 A <ul style="list-style-type: none"> • For use with Bulletin 103T/107T 3-component starters 	140M-C, -D to 100-C09...C23	140M-C-PSC23	
	140M-D, -F to 100-C30...C43	140M-F-PSC43	
	Spacing Adapter <ul style="list-style-type: none"> • Required for self-protected combination motor controller (Type E) applications of Bul. 140M-C, -D, and -F MPCBs. Not for use with bus bars. 	140M-C, -D	140M-C-TE1
		140M-F	140M-F-TE

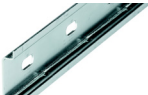
	Description	For Use With	Cat. No.
	Feeder Block for Compact Busbar • Supply of compact busbars Increases terminal capacity	140M-C	140M-C-WBE
		140M-F	140M-F-WBE
	Feeder Terminal for Compact Busbar • For supply of compact busbars • Top feed — overlaps compact busbar • Meets IEC spacing requirements	140M-C, -D	140M-C-WTN
	Feeder Terminal for Compact Busbar • For supply of compact busbars • Top feed — overlaps compact busbar • Meets UL Type E spacing requirements	140M-C, -D	140M-C-WTEN
		140M-F	140M-F-WTE
	Three-phase Compact Busbar for 32 A Motor Protection Circuit Breakers — 64 A Max. Continuous Current • 45 mm spacing • For use with front-mounted auxiliary contact	2 connections	140M-C-W452N
		3 connections	140M-C-W453N
		4 connections	140M-C-W454N
		5 connections	140M-C-W455N
	Three-phase Compact Busbar for 32 A Motor Protection Circuit Breakers — 64 A Max. Continuous Current • 54 mm spacing • For use with side-mounted auxiliary contact	2 connections	140M-C-W542N
		3 connections	140M-C-W543N
		4 connections	140M-C-W544N
		5 connections	140M-C-W545N
	Three-phase Compact Busbar for 45 A Motor Protection Circuit Breakers — 115 A Max. Continuous Current • 54 mm spacing • For use with front-mounted auxiliary contact	2 connections	140M-F-W542
		3 connections	140M-F-W543
		4 connections	140M-F-W544
		Three-phase Compact Busbar for 45 A Motor Protection Circuit Breakers — 115 A Max. Continuous Current • 63 mm spacing • For use with side-mounted auxiliary contact	2 connections
3 connections	140M-F-W633		
4 connections	140M-F-W634		
	Terminal Cover • For covering of unused compact bus bar terminals IP2X finger protection • Must be ordered in multiples of 10 • (10 pcs/pkg)	140M-C, -D	140M-C-WSN
		140M-F	140M-F-WS
	Top Hat Rail Adapter — 10 mm • Adjusts the depth of the 140M-C to the 140M-D • Allows the use of compact busbars across both frame sizes • Must be ordered in multiples of 10 • (10 pcs/pkg)	140M-C	140-KBH2
	DIN (#3) symmetrical hat rail • 35 x 7.5 x 1 m • (10 pcs/pkg)	140M-D, -F	199-DR1
	DIN (#3) Symmetrical Rail • 35 mm x 15 mm x 1 m long • Top Hat Rail (DIN #3 Symmetrical Rail) • (5 pcs/pkg)	140M-C, -D, -F	1492-DR9

Notes:

Specifications

Application Ratings

UL/CSA Listed Application Ratings, Motor Protection Circuit Breaker Only

Cat. No.	UL 508 — Manual Motor Controller							UL 508 Self-Protected (Type E) Combination Motor Controller	
	Max. Fuse or C.B. per NEC	Group Motor Installation		Motor Disconnect		Tap Conductor Protection		Max. Short Circuit Current [kA]	
		480V	600V	480V	600V	480V/277V ⁽¹⁾	600V/347V ⁽¹⁾	480V/277V ⁽¹⁾	600V/347V ⁽¹⁾
C-Frame									
140M-C2E-A16	450	65	47	65	47	65	47	65	47
140M-C2E-A25	450	65	47	65	47	65	47	65	47
140M-C2E-A40	450	65	47	65	47	65	47	65	47
140M-C2E-A63	450	65	47	65	47	65	47	65	47
140M-C2E-B10	450	65	47	65	47	65	47	65	47
140M-C2E-B16	450	65	47	65	47	65	47	65	47
140M-C2E-B25	450	65	30	65	30	65	30	65	30
140M-C2E-B40	450	65	25	65	25	65	25	65	25
140M-C2E-B63	450	65	30	65	30	65	—	65	—
140M-C2E-C10	450	65	30	65	30	65	—	65	—
140M-C2E-C16	450	30	30	30	30	30	—	30	—
140M-C2E-C20	450	30	30	10	10	10	—	10	—
140M-C2E-C25	450	25	10	10	5	—	—	—	—
140M-C2E-C29	450	25	5	10	—	—	—	—	—
140M-C2E-C32	450	25	5	10	—	—	—	—	—
140M-C2T-A16	450	65	47	65	47	65	47	65	47
140M-C2T-A25	450	65	47	65	47	65	47	65	47
140M-C2T-A40	450	65	47	65	47	65	47	65	47
140M-C2T-A63	450	65	47	65	47	65	47	65	47
140M-C2T-B10	450	65	47	65	47	65	47	65	47
140M-C2T-B16	450	65	47	65	47	65	30	65	30
140M-C2T-B25	450	65	25	65	25	65	25	65	25
140M-C2T-B40	450	65	30	65	30	65	—	65	—
140M-C2T-B63	450	65	30	65	30	65	—	65	—
140M-C2T-C10	450	30	30	30	30	30	—	30	—
140M-C2T-C16	450	30	30	10	10	10	—	10	—
D-Frame (D8E)									
140M-D8E-B25	450	65	30	65	30	65	30	65	30
140M-D8E-B40	450	65	30	65	30	65	30	65	30
140M-D8E-B63	450	65	30	65	30	65	30	65	30
140M-D8E-C10	450	65	30	65	30	65	30	65	30
140M-D8E-C16	450	65	30	65	30	65	30	65	30
140M-D8E-C20	450	65	30	65	30	65	—	65	—
140M-D8E-C25	450	30	30	30	30	30	—	30	—
140M-D8E-C29	450	30	30	30	18	—	—	—	—
140M-D8E-C32	450	30	30	30	18	—	—	—	—

(1) For full voltage (delta) ratings above 277V or 347V, follow the NEC or CEC rules for group motor applications.

Cat. No.	UL 508 — Manual Motor Controller							UL 508 Self-Protected (Type E) Combination Motor Controller	
	Max. Fuse or C.B. per NEC	Group Motor Installation		Motor Disconnect		Tap Conductor Protection		Max. Short Circuit Current [kA]	
		Max. Short Circuit Current [kA]	480V	600V	480V	600V	480Y/277V ⁽¹⁾	600Y/347V ⁽¹⁾	480Y/277V ⁽¹⁾
D-Frame (D8V, D8T)									
140M-D8T-C16	450	65	30	65	30	65	30	65	30
140M-D8T-C20	450	30	30	30	30	30	—	30	—
140M-D8V-B16	450	65	—	65	—	65	—	65	—
140M-D8V-B25	450	65	—	65	—	65	—	65	—
140M-D8V-B40	450	65	—	65	—	65	—	65	—
140M-D8V-B63	450	65	—	65	—	65	—	65	—
140M-D8V-C10	450	65	—	65	—	65	—	65	—
140M-D8V-C16	450	65	—	65	—	65	—	65	—
140M-D8V-C20	450	65	—	65	—	65	—	65	—
140M-D8V-C25	450	30	—	30	—	30	—	30	—
140M-D8V-C29	450	30	—	30	—	—	—	—	—
140M-D8V-C32	450	30	—	30	—	—	—	—	—
F-Frame									
140M-F8E-C10	600	65	30	65	30	65	30	65	30
140M-F8E-C16	600	65	30	65	30	65	30	65	30
140M-F8E-C20	600	65	30	65	30	65	30	65	30
140M-F8E-C25	600	65	30	65	30	65	30	65	30
140M-F8E-C32	600	65	30	65	30	65	30	65	30
140M-F8E-C45	600	65	18	65	18	65	—	65	—
140M-F8T-C25	600	65	30	65	30	65	30	65	30
140M-F8T-C32	600	65	18	65	18	65	18	65	18

(1) For full voltage (delta) ratings above 277V or 347V, follow the NEC or CEC rules for group motor applications.

UL Listed Application Ratings, Motor Circuit Protector Only
(Separate Overload Protection Required)

Cat. No.	UL 508 — Manual Motor Controller				
	Max. Fuse or C.B. per NEC	Group Motor Installation		Motor Disconnect	
		Max. Short Circuit Current [kA]		Max. Short Circuit Current [kA]	
		480V	600V	480V	600V
C-Frame					
140M-C2N-A16	450	65	47	65	47
140M-C2N-A25	450	65	47	65	47
140M-C2N-A40	450	65	47	65	47
140M-C2N-A63	450	65	47	65	47
140M-C2N-B10	450	65	47	65	47
140M-C2N-B16	450	65	47	65	47
140M-C2N-B25	450	65	30	65	30
D-Frame					
140M-D8N-B25	450	65	30	65	30
140M-D8N-B40	450	65	30	65	30
140M-D8N-B63	450	65	30	65	30
140M-D8N-C10	450	65	30	65	30
140M-D8N-C16	450	65	30	65	30
140M-D8N-C25	450	30	30	30	30
140M-D8N-C32	450	30	30	30	18
F-Frame					
140M-F8N-C25	600	65	30	65	30
140M-F8N-C32	600	65	30	65	30
140M-F8N-C45	600	65	18	65	18

UL Listed Application Ratings - Motor Protection Circuit Breakers with Bulletin 100-K Contactors

Cat. No.	UL 508 — Manual Motor Controller						UL508 Type F Combination Motor Controller		
	Max. Fuse or C.B. per NEC	Minimum Contactor Size	Group Motor Installation		Motor Disconnect		Minimum Contactor Size	Max. Short Circuit Current [kA]	
			Max. Short Circuit Current [kA]		Max. Short Circuit Current [kA]			480Y/277V ⁽¹⁾	600Y/347V ⁽¹⁾
			480V	600V	480V	600V			
C-Frame									
140M-C2E-A16	450	100-K05	65	47	65	47	100-K05	65	47
140M-C2E-A25	450	100-K05	65	47	65	47	100-K05	65	47
140M-C2E-A40	450	100-K05	65	47	65	47	100-K05	65	47
140M-C2E-A63	450	100-K05	65	47	65	47	100-K05	65	47
140M-C2E-B10	450	100-K05	65	47	65	47	100-K05	65	47
140M-C2E-B16	450	100-K05	65	47	65	47	100-K05	65	47
140M-C2E-B25	450	100-K05	65	30	65	30	100-K05	65	30
140M-C2E-B40	450	100-K05	65	30	65	30	100-K05	65	30
140M-C2E-B63	450	100-K05	65	30	65	30	100-K05	65	—
140M-C2E-C10	450	100-K09	65	30	65	30	100-K09	65	—
140M-C2E-C16	450	100-K12	30	30	30	30	100-K12	30	—
D-Frame									
140M-D8E-B25	450	100-K05	65	30	65	30	100-K05	65	30
140M-D8E-B40	450	100-K05	65	30	65	30	100-K05	65	30
140M-D8E-B63	450	100-K05	65	30	65	30	100-K05	65	30
140M-D8E-C10	450	100-K09	65	30	65	30	100-K09	65	30
140M-D8E-C16	450	100-K12	65	30	65	30	100-K12	65	30

(1) For full voltage (delta) ratings above 277V or 347V, follow the NEC or CEC rules for group motor applications.

UL Listed Application Ratings - Motor Protection Circuit Breakers with Bulletin 100-C Contactors

Cat. No.	UL 508 — Manual Motor Controller						UL508 Type F Combination Motor Controller			UL508 Type E Self-Protected Combination Motor Controller		
	Max. Fuse or C.B. per NEC	Minimum Contactor Size	Group Motor Installation		Motor Disconnect		Minimum Contactor Size	Max. Short Circuit Current [kA]		Minimum Contactor Size	Max. Short Circuit Current [kA]	
			Max. Short Circuit Current [kA]		Max. Short Circuit Current [kA]			Max. Short Circuit Current [kA]			Max. Short Circuit Current [kA]	
			480V	600V	480V	600V		480V/ 277V ⁽¹⁾	600V/ 347V ⁽¹⁾		480V/ 277V ⁽¹⁾	600V/ 347V ⁽¹⁾
C-Frame												
140M-C2E-A16	450	100-C09	65	47	65	47	100-C09	65	47	100-C09	65	47
140M-C2E-A25	450	100-C09	65	47	65	47	100-C09	65	47	100-C09	65	47
140M-C2E-A40	450	100-C09	65	47	65	47	100-C09	65	47	100-C09	65	47
140M-C2E-A63	450	100-C09	65	47	65	47	100-C09	65	47	100-C09	65	47
140M-C2E-B10	450	100-C09	65	47	65	47	100-C09	65	47	100-C09	65	47
140M-C2E-B16	450	100-C09	65	47	65	47	100-C09	65	47	100-C09	65	47
140M-C2E-B25	450	100-C09	65	30	65	30	100-C09	65	30	100-C09	65	30
140M-C2E-B40	450	100-C09	65	30	65	30	100-C09	65	30	—	65	25
140M-C2E-B63	450	100-C09	65	30	65	30	100-C09	65	—	—	65	—
140M-C2E-C10	450	100-C09	65	30	65	30	100-C09	65	—	—	65	—
140M-C2E-C16	450	100-C12	30	30	30	25	100-C12	30	—	—	30	—
140M-C2E-C20	450	100-C16	30	30	30	30	100-C23	10	—	—	10	—
140M-C2E-C25	450	100-C23	30	30	10	10	—	—	—	—	—	—
	450	100-C30	30	30	30	30	—	—	—	—	—	—
140M-C2E-C29	450	100-C30	10	5	10	5	—	—	—	—	—	—
140M-C2E-C32	450	100-C37	10	5	10	5	—	—	—	—	—	—
D-Frame												
140M-D8E-B25	450	100-C09	65	30	65	30	100-C09	65	30	100-C09	65	30
	—	—	—	—	—	—	—	—	—	100-C23	65	30
140M-D8E-B40	450	100-C09	65	30	65	30	100-C09	65	30	100-C23	65	30
140M-D8E-B63	450	100-C09	65	30	65	30	100-C09	65	30	100-C30	65	30
140M-D8E-C10	450	100-C09	65	30	65	30	100-C09	65	30	100-C30	65	30
140M-D8E-C16	450	100-C12	65	30	65	30	100-C12	65	30	100-C30	65	30
140M-D8E-C20	450	100-C23	65	30	65	30	100-C23	65	—	100-C30	65	—
140M-D8E-C25	450	100-C23	65	30	65	30	100-C23	30	—	100-C30	30	—
140M-D8E-C29	450	100-C30	65	10	65	10	—	—	—	—	—	—
140M-D8E-C32	450	100-C37	65	10	65	10	—	—	—	—	—	—
F-Frame												
140M-F8E-C10	600	100-C30	65	30	65	30	100-C30	65	30	100-C30	65	30
140M-F8E-C16	600	100-C30	65	30	65	30	100-C30	65	30	100-C30	65	30
140M-F8E-C20	600	100-C30	65	30	65	30	100-C30	65	30	100-C30	65	30
140M-F8E-C25	600	100-C30	65	30	65	30	100-C30	65	30	100-C30	65	30
140M-F8E-C32	600	100-C30	65	30	65	30	100-C30	65	30	100-C30	65	30
140M-F8E-C45	600	100-C37	65	18	65	18	100-C37	65	—	100-C37	65	—

(1) For full voltage (delta) ratings above 277V or 347V, follow the NEC or CEC rules for group motor applications.

UL Listed Application Ratings - Motor Circuit Protectors with Bulletin 100-C Contactors (Separate Overload Protection Required)

Cat. No.	UL 508 — Manual Motor Controller						UL508 Type E Self-Protected Combination Motor Controller		
	Max. Fuse or C.B. per NEC	Minimum Contactor Size	Group Motor Installation		Motor Disconnect		Minimum Contactor Size	Max. Short Circuit Current [kA]	
			Max. Short Circuit Current [kA]		Max. Short Circuit Current [kA]			480Y/277V ⁽¹⁾	600Y/347V ⁽¹⁾
			480V	600V	480V	600V			
C-Frame									
140M-C2N-A16	450	100-C09	65	47	65	47	100-C09	65	47
140M-C2N-A25	450	100-C09	65	47	65	47	100-C09	65	47
140M-C2N-A40	450	100-C09	65	47	65	47	100-C09	65	47
140M-C2N-A63	450	100-C09	65	47	65	47	100-C09	65	47
140M-C2N-B10	450	100-C09	65	47	65	47	100-C09	65	47
140M-C2N-B16	450	100-C09	65	47	65	47	100-C09	65	47
140M-C2N-B25	450	100-C09	65	30	65	30	100-C09	65	—
D-Frame									
140M-D8N-B25	450	100-C09	65	30	65	30	100-C09	65	—
	—	—	—	—	—	—	100-C23	65	30
140M-D8N-B40	450	100-C09	65	30	65	30	100-C23	65	30
140M-D8N-B63	450	100-C09	65	30	65	30	100-C30	65	30
140M-D8N-C10	450	100-C09	65	30	65	30	100-C30	65	30
140M-D8N-C16	450	100-C12	65	30	65	30	100-C30	65	30
140M-D8N-C25	450	100-C23	30	30	30	30	100-C30	65	—
140M-D8N-C32	450	100-C37	65	10	65	10	—	—	—
F-Frame									
140M-F8N-C25	600	100-C23	65	30	65	30	100-C30	65	30
140M-F8N-C32	600	100-C30	65	30	65	30	100-C30	65	30
140M-F8N-C45	600	100-C37	65	18	65	18	100-C37	65	—

(1) For full-voltage (delta) ratings above 277V or 347V, follow the NEC or CEC rules for group motor applications.

Definition of Type 2 Short Circuit Coordination:

- The contactor or starter must not endanger persons or plant in the event of a short circuit.
- No damage to the motor protection device or other parts may occur with the exception of welding of the contactor or starter contacts if these can be easily separated without appreciable deformation (such as with a screwdriver).

In the event of short circuit, fast-opening, current-limiting Bulletin 140M Motor Protection Circuit Breakers make it possible to build economical, fully short-circuit coordinated starter combinations with Type 2 coordination.

Type 2 Coordination, 400V

Cat. No.			Max. Short-Circuit Current [kA]	Minimum Contactor Size
Standard Motor Protection	High Inrush Motor Protection	Motor Circuit Protection		
C-Frame				
140M-C2E-A16	—	140M-C2N-A16	100	100-C09
140M-C2E-A25	140M-C2T-A16	140M-C2N-A25	100	100-C09
140M-C2E-A40	140M-C2T-A25	140M-C2N-A40	100	100-C09
140M-C2E-A63	140M-C2T-A40	140M-C2N-A63	100	100-C09
140M-C2E-B10	140M-C2T-A63	140M-C2N-B10	100	100-C09
140M-C2E-B16	140M-C2T-B10	140M-C2N-B16	100	100-C09
140M-C2E-B25	140M-C2T-B16	140M-C2N-B25	50	100-C09
140M-C2E-B40	140M-C2T-B25	—	50	100-C09
140M-C2E-B63	140M-C2T-B40	—	50	100-C09
140M-C2E-C10	140M-C2T-B63	—	50	100-C09
140M-C2E-C16	140M-C2T-C10	—	50	100-C12 ⁽¹⁾
140M-C2E-C20	140M-C2T-C16	—	50	100-C23
140M-C2E-C25	—	—	15	100-C30
140M-C2E-C29	—	—	15	100-C30
140M-C2E-C32	—	—	15	100-C37
D-Frame				
140M-D8E-B25	—	140M-D8N-B25	100	100-C09
140M-D8E-B40	—	140M-D8N-B40	100	100-C09
140M-D8E-B63	—	140M-D8N-B63	100	100-C09
140M-D8E-C10	—	140M-D8N-C10	65	100-C09
140M-D8E-C16	—	140M-D8N-C16	65	100-C12
140M-D8E-C20	140M-D8T-C16	—	65	100-C23
140M-D8E-C25	140M-D8T-C20	140M-D8N-C25	50	100-C23
140M-D8E-C29	—	—	65	100-C30
140M-D8E-C32	—	140M-D8N-C32	65	100-C37
F-Frame				
140M-F8E-C10	—	—	100	100-C09
140M-F8E-C16	—	—	100	100-C12
140M-F8E-C20	—	—	100	100-C23
140M-F8E-C25	—	140M-F8N-C25	100	100-C30
140M-F8E-C32	140M-F8T-C25	140M-F8N-C32	100	100-C30
140M-F8E-C45	140M-F8T-C32	140M-F8N-C45	100	100-C37

(1) Cat. No. 100-C16 contactors Type 1 only

Type 2 Coordination, 480V

Cat. No.			Max. Short-Circuit Current [kA]	Minimum Contactor Size
Standard Motor Protection	High Inrush Motor Protection	Motor Circuit Protection		
C-Frame				
140M-C2E-A16	—	140M-C2N-A16	65	100-C09
140M-C2E-A25	140M-C2T-A16	140M-C2N-A25	65	100-C09
140M-C2E-A40	140M-C2T-A25	140M-C2N-A40	65	100-C09
140M-C2E-A63	140M-C2T-A40	140M-C2N-A63	65	100-C09
140M-C2E-B10	140M-C2T-A63	140M-C2N-B10	65	100-C09
140M-C2E-B16	140M-C2T-B10	140M-C2N-B16	65	100-C09
140M-C2E-B25	140M-C2T-B16	140M-C2N-B25	50	100-C16
140M-C2E-B40	140M-C2T-B25	—	50	100-C30
140M-C2E-B63	140M-C2T-B40	—	50	100-C30
140M-C2E-C10	140M-C2T-B63	—	50	100-C30
140M-C2E-C16	140M-C2T-C10	—	10	100-C30
140M-C2E-C20	140M-C2T-C16	—	10	100-C30
140M-C2E-C25	—	—	10	100-C30
140M-C2E-C29	—	—	10	100-C30
140M-C2E-C32	—	—	10	100-C37
D-Frame				
140M-D8E-B25	—	140M-D8N-B25	65	100-C09
140M-D8E-B40	—	140M-D8N-B40	65	100-C09
140M-D8E-B63	—	140M-D8N-B63	65	100-C09
140M-D8E-C10	—	140M-D8N-C10	65	100-C09
140M-D8E-C16	—	140M-D8N-C16	65	100-C12
140M-D8E-C20	140M-D8T-C16	—	65	100-C23
140M-D8E-C25	140M-D8T-C20	140M-D8N-C25	65	100-C23
140M-D8E-C29	—	—	65	100-C30
140M-D8E-C32	—	140M-D8N-C32	65	100-C37
F-Frame				
140M-F8E-C10	—	—	65	100-C09
140M-F8E-C16	—	—	65	100-C12
140M-F8E-C20	—	—	65	100-C23
140M-F8E-C25	—	140M-F8N-C25	65	100-C30
140M-F8E-C32	140M-F8T-C25	140M-F8N-C32	65	100-C30
140M-F8E-C45	140M-F8T-C32	140M-F8N-C45	65	100-C37

Type 2 Coordination, 600V

Cat. No.			Max. Short-Circuit Current [kA]	Minimum Contactor Size
Standard Motor Protection	High Inrush Motor Protection	Motor Circuit Protection	600V	
C-Frame				
140M-C2E-A16	—	140M-C2N-A16	47	100-C09
140M-C2E-A25	140M-C2T-A16	140M-C2N-A25	47	100-C09
140M-C2E-A40	140M-C2T-A25	140M-C2N-A40	47	100-C09
140M-C2E-A63	140M-C2T-A40	140M-C2N-A63	47	100-C09
140M-C2E-B10	140M-C2T-A63	140M-C2N-B10	47	100-C09
140M-C2E-B16	140M-C2T-B10	140M-C2N-B16	47	100-C09
140M-C2E-B25	140M-C2T-B16	140M-C2N-B25	10	100-C16
140M-C2E-B40	140M-C2T-B25	—	10	100-C16
140M-C2E-B63	140M-C2T-B40	—	5	100-C23
140M-C2E-C10	140M-C2T-B63	—	5	100-C30
140M-C2E-C16	140M-C2T-C10	—	5	100-C30
140M-C2E-C20	140M-C2T-C16	—	5	100-C30
140M-C2E-C25	—	—	5	100-C30
140M-C2E-C29	—	—	5	100-C30
140M-C2E-C32	—	—	5	100-C37
D-Frame				
140M-D8E-B25	—	140M-D8N-B25	30	100-C30
140M-D8E-B40	—	140M-D8N-B40	30	100-C30
140M-D8E-B63	—	140M-D8N-B63	30	100-C30
140M-D8E-C10	—	140M-D8N-C10	30	100-C30
140M-D8E-C16	—	140M-D8N-C16	30	100-C30
140M-D8E-C20	140M-D8T-C16	—	5	100-C30
140M-D8E-C25	140M-D8T-C20	140M-D8N-C25	5	100-C30
140M-D8E-C29	—	—	10	100-C30
140M-D8E-C32	—	140M-D8N-C32	10	100-C37
F-Frame				
140M-F8E-C10	—	—	30	100-C30
140M-F8E-C16	—	—	30	100-C30
140M-F8E-C20	—	—	30	100-C30
140M-F8E-C25	—	140M-F8N-C25	30	100-C30
140M-F8E-C32	140M-F8T-C25	140M-F8N-C32	30	100-C30
140M-F8E-C45	140M-F8T-C32	140M-F8N-C45	10	100-C37

IEC Performance Data

		Cat.No.140M-C2E-															
		A16	A25	A40	A63	B10	B16	B25	B40	B63	C10	C16	C20	C25	C29	C32	
Rated Operational Current, I_e	[A]	0.16	0.25	0.4	0.63	1	1.6	2.5	4	6.3	10	16	20	25	29	32	
Magnetic Release Current	[A]	2.1	3.3	5.2	8.2	13	21	33	52	82	130	208	260	325	406	448	
Switching of Standard Three-Phase Motors, AC-3																	
230/240V	[kW]	—	—	0.06	0.09	0.18	0.25	0.37	0.75	1.5	2.2	4.0	5.5	5.5	7.5	7.5	
400/415V	[kW]	0.02	0.04	0.09	0.18	0.25	0.55	0.75	1.5	2.2	4.0	7.5	10	11	13	15	
500V	[kW]	0.06	0.09	0.12	0.18	0.37	0.75	1.1	2.2	3.0	6.3	10	11	15	18.5	20	
690V	[kW]	0.06	0.09	0.18	0.25	0.55	1.1	1.8	3.0	4.0	7.5	13	17	22	25	25	
Back-Up Fuses gG, gL, only if $I_{cc} \geq I_{cu}$																	
230/240V	[A]	(1)	(1)	(1)	(1)	(1)	(1)	(1)	(1)	(1)	(1)	(1)	(1)	100	100	125	125
400/415V	[A]	(1)	(1)	(1)	(1)	(1)	(1)	(1)	(1)	(1)	(1)	(1)	80	100	100	125	125
440/460V	[A]	(1)	(1)	(1)	(1)	(1)	(1)	(1)	(1)	(1)	(1)	63	80	80	80	100	100
500V	[A]	(1)	(1)	(1)	(1)	(1)	(1)	(1)	(1)	(1)	(1)	80	80	80	80	100	100
690V	[A]	(1)	(1)	(1)	(1)	(1)	16	20	35	50	50	63	63	63	80	80	
Ultimate Short Circuit Breaking Capacity, I_{cu}																	
230/240V	[kA]	100	100	100	100	100	100	100	100	100	100	100	100	65	65	50	50
400/415V	[kA]	100	100	100	100	100	100	100	100	100	100	100	65	50	15	15	15
440/460V	[kA]	100	100	100	100	100	100	100	100	100	50	10	6	6	6	6	
500V	[kA]	100	100	100	100	100	100	100	100	100	50	10	6	6	6	6	
690V	[kA]	100	100	100	100	100	8	6	6	4	4	3	3	3	3	3	
Rated Service Short Circuit Breaking Capacity, I_{cs}																	
230/240V	[kA]	100	100	100	100	100	100	100	100	100	100	100	100	50	50	25	25
400/415V	[kA]	100	100	100	100	100	100	100	100	100	100	100	50	15	15	15	15
440/460V	[kA]	100	100	100	100	100	100	100	100	100	50	6	6	6	6	6	
500V	[kA]	100	100	100	100	100	100	100	100	100	50	6	6	6	6	6	
690V	[kA]	100	100	100	100	100	8	6	6	4	4	3	3	3	3	3	

(1) No back-up fuse required.

		Cat.No.140M-D8E-									Cat.No.140M-F8E-					
		B25	B40	B63	C10	C16	C20	C25	C29	C32	C10	C16	C20	C25	C32	C45
Rated Operational Current, I_e	[A]	2.5	4.0	6.3	10	16	20	25	29	32	10	16	20	25	32	45
Magnetic Release Current	[A]	33	52	82	130	208	260	325	406	448	130	208	260	325	416	585

Switching of Standard Three-Phase Motors, AC-3

230/240V	[kW]	0.37	0.75	1.5	2.2	4.0	5.5	5.5	7.5	7.5	2.2	4.0	5.5	6.3	7.5	13
400/415V	[kW]	0.75	1.5	2.2	4.0	7.5	10	11	13	15	4.0	7.5	10	11	15	22
500V	[kW]	1.1	2.2	3.0	6.3	10	11	15	18.5	20	6.3	10	11	15	20	30
690V	[kW]	1.8	3.0	4.0	7.5	13	17	22	25	25	7.5	13	17	22	30	40

Back-Up Fuses gG, gL, only if $I_{cc} \geq I_{cu}$

230/240V	[A]	(1)	(1)	(1)	(1)	(1)	(1)	(1)	(1)	(1)	(1)	(1)	(1)	(1)	(1)	(1)
400/415V	[A]	(1)	(1)	(1)	(1)	(1)	100	100	125	125	80	100	100	100	125	125
440/460V	[A]	(1)	(1)	(1)	(1)	80	100	100	125	125	80	100	100	100	125	125
500V	[A]	(1)	(1)	(1)	(1)	80	80	80	100	100	80	100	100	100	125	125
690V	[A]	20	35	50	50	63	63	63	80	80	63	80	80	80	100	100

Ultimate Short Circuit Breaking Capacity, I_{cu}

230/240V	[kA]	100	100	100	100	100	100	100	65	65	100	100	100	100	100	100
400/415V	[kA]	100	100	100	100	100	100	65	50	50	100	100	100	100	65	65
440/460V	[kA]	100	100	100	50	50	50	50	25	25	65	65	65	65	65	50
500V	[kA]	100	100	100	50	50	50	50	25	25	50	50	50	50	50	50
690V	[kA]	10	10	6	6	6	6	6	6	6	10	10	10	10	10	10

Rated Service Short Circuit Breaking Capacity, I_{cs}

230/240V	[kA]	100	100	100	100	100	100	100	50	50	100	100	100	100	100	100
400/415V	[kA]	100	100	100	100	50	25	25	25	25	50	50	50	50	50	50
440/460V	[kA]	100	100	100	50	50	25	25	20	20	50	50	50	50	50	50
500V	[kA]	100	100	100	50	50	25	25	20	20	50	50	50	50	50	50
690V	[kA]	10	10	6	6	4	4	4	4	4	10	10	10	10	6	6

(1) No back-up fuse required.

		Cat. No. 140M-D8V-									
		B16	B25	B40	B63	C10	C16	C20	C25	C29	C32
Rated Operational Current, I_e	[A]	1.6	2.5	4	6.3	10	16	20	25	29	32
Magnetic Release Current	[A]	82	82	82	82	130	208	260	325	406	448
Switching of Standard Three-Phase Motors, AC-3											
230/240V	[kW]	0.25	0.37	0.75	1.5	2.2	4	5.5	5.5	7.5	7.5
400/415V	[kW]	0.55	0.75	1.5	2.2	4	7.5	10	11	13	15
500V	[kW]	0.75	1.1	2.2	3	6.3	10	11	15	18.5	20
Back-Up Fuses gG, gL, only if $I_{cc} \geq I_{cu}$											
230/240V	[A]	(1)	(1)	(1)	(1)	(1)	(1)	(1)	(1)	(1)	(1)
400/415V	[A]	(1)	(1)	(1)	(1)	(1)	(1)	100	100	125	125
440/460V	[A]	(1)	(1)	(1)	(1)	(1)	80	100	100	125	125
500V	[A]	(1)	(1)	(1)	(1)	(1)	80	80	80	100	100
Ultimate Short Circuit Breaking Capacity, I_{cu}											
230/240V	[kA]	65	65	65	65	65	65	65	65	65	65
400/415V	[kA]	65	65	65	65	65	65	65	65	50	50
440/460V	[kA]	65	65	65	65	50	50	50	50	25	25
500V	[kA]	65	65	65	65	50	50	50	50	25	25
Rated Service Short Circuit Breaking Capacity, I_{cs}											
230/240V	[kA]	65	65	65	65	65	65	65	65	50	50
400/415V	[kA]	65	65	65	65	65	50	25	25	25	25
440/460V	[kA]	65	65	65	65	50	50	25	25	20	20
500V	[kA]	65	65	65	65	50	50	25	25	20	20

(1) No back-up fuse required.

		Cat.No.140M-C2N-						
		A16	A25	A40	A63	B10	B16	B25
Rated Operational Current, I_e	[A]	0.16	0.25	0.4	0.63	1	1.6	2.5
Magnetic Release Current	[A]	2.1	3.3	5.2	8.2	13	21	32
Switching of Standard Three-Phase Motors, AC-3								
230/240V	[kW]	—	—	0.06	0.09	0.18	0.25	0.37
400/415V	[kW]	0.02	0.04	0.09	0.18	0.25	0.55	0.75
500V	[kW]	0.06	0.09	0.12	0.18	0.37	0.75	1.1
690V	[kW]	0.06	0.09	0.18	0.25	0.55	1.1	1.8
Back-Up Fuses gG, gL, only if $I_{cc} \geq I_{cu}$								
230/240V	[A]	(1)	(1)	(1)	(1)	(1)	(1)	(1)
400/415V	[A]	(1)	(1)	(1)	(1)	(1)	(1)	(1)
440/460V	[A]	(1)	(1)	(1)	(1)	(1)	(1)	(1)
500V	[A]	(1)	(1)	(1)	(1)	(1)	(1)	(1)
690V	[A]	(1)	(1)	(1)	(1)	(1)	16	20
Ultimate Short Circuit Breaking Capacity, I_{cu}								
230/240V	[kA]	100	100	100	100	100	100	100
400/415V	[kA]	100	100	100	100	100	100	100
440/460V	[kA]	100	100	100	100	100	100	100
500V	[kA]	100	100	100	100	100	100	100
690V	[kA]	100	100	100	100	100	10	6
Rated Service Short Circuit Breaking Capacity, I_{cs}								
230/240V	[kA]	100	100	100	100	100	100	100
400/415V	[kA]	100	100	100	100	100	100	100
440/460V	[kA]	100	100	100	100	100	100	100
500V	[kA]	100	100	100	100	100	100	100
690V	[kA]	100	100	100	100	100	8	6

(1) No back-up fuse required.

		Cat.No.140M-D8N-						Cat.No.140M-F8N-			
		B25	B63	B40	C10	C16	C25	C32	C25	C32	C45
Rated Operational Current, I_e	[A]	2.5	4.0	6.3	10	16	25	32	25	32	45
Magnetic Release Current	[A]	32	52	82	130	208	325	448	325	416	585
Switching of Standard Three-Phase Motors, AC-3											
230/240V	[kW]	0.37	0.75	1.5	2.2	4.0	5.5	7.5	6.3	7.5	13
400/415V	[kW]	0.75	1.5	2.2	4.0	7.5	11	15	11	15	22
500V	[kW]	1.1	2.2	3.0	6.3	10	15	20	15	20	30
690V	[kW]	1.8	3.0	4.0	7.5	13	22	25	22	30	40
Back-Up Fuses gG, gL, only if $I_{cc} \geq I_{cu}$											
230/240V	[A]	(1)	(1)	(1)	(1)	(1)	(1)	(1)	100	125	125
400/415V	[A]	(1)	(1)	(1)	(1)	(1)	100	125	100	125	125
440/460V	[A]	(1)	(1)	(1)	(1)	80	100	125	100	125	125
500V	[A]	(1)	(1)	(1)	(1)	80	80	100	100	125	125
690V	[A]	20	35	50	50	63	63	80	80	100	100
Ultimate Short Circuit Breaking Capacity, I_{cu}											
230/240V	[kA]	100	100	100	100	100	100	65	100	100	100
400/415V	[kA]	100	100	100	100	100	65	50	100	65	65
440/460V	[kA]	100	100	100	50	50	50	25	65	65	50
500V	[kA]	100	100	100	50	50	25	25	50	50	50
690V	[kA]	10	6	10	6	6	6	6	10	10	10
Rated Service Short Circuit Breaking Capacity, I_{cs}											
230/240V	[kA]	100	100	100	100	100	100	50	100	100	100
400/415V	[kA]	100	100	100	100	50	25	25	50	50	50
440/460V	[kA]	100	100	100	50	50	25	20	50	50	50
500V	[kA]	100	100	100	50	50	25	20	50	50	50
690V	[kA]	10	6	10	6	4	4	4	10	6	6

(1) No back-up fuse required.

		Cat.No.140M-C2T-										
		A16	A25	A40	A63	B10	B16	B25	B40	B63	C10	C16
Rated Operational Current, I_e	[A]	0.16	0.25	0.40	0.63	1.0	1.6	2.5	4.0	6.3	10	16
Magnetic Release Current	[A]	3.2	5.2	8.2	13	21	32	52	82	130	208	260
Switching of Standard Three-Phase Motors, AC-3												
230/240V	[kW]	—	—	0.06	0.09	0.18	0.25	0.37	0.75	1.5	2.2	4.0
400/415V	[kW]	0.02	0.04	0.09	0.18	0.25	0.55	0.75	1.5	2.2	4.0	7.5
500V	[kW]	0.06	0.09	0.12	0.18	0.37	0.75	1.1	2.2	3.0	6.3	10
690V	[kW]	0.06	0.09	0.18	0.25	0.55	1.1	1.8	3.0	4.0	7.5	13
Back-Up Fuses gG, gL, only if $I_{cc} \geq I_{cu}$												
230/240V	[A]	(1)	(1)	(1)	(1)	(1)	(1)	(1)	(1)	(1)	(1)	(1)
400/415V	[A]	(1)	(1)	(1)	(1)	(1)	(1)	(1)	(1)	(1)	(1)	80
440/460V	[A]	(1)	(1)	(1)	(1)	(1)	(1)	(1)	(1)	(1)	63	80
500V	[A]	(1)	(1)	(1)	(1)	(1)	(1)	(1)	(1)	(1)	80	80
690V	[A]	(1)	(1)	(1)	(1)	(1)	16	20	35	50	50	63
Ultimate Short Circuit Breaking Capacity, I_{cu}												
230/240V	[kA]	100	100	100	100	100	100	100	100	100	100	100
400/415V	[kA]	100	100	100	100	100	100	100	100	100	100	50
440/460V	[kA]	100	100	100	100	100	100	100	100	100	10	10
500V	[kA]	100	100	100	100	100	100	100	100	100	10	10
690V	[kA]	100	100	100	100	100	8	6	6	4	4	3
Rated Service Short Circuit Breaking Capacity, I_{cs}												
230/240V	[kA]	100	100	100	100	100	100	100	100	100	100	100
400/415V	[kA]	100	100	100	100	100	100	100	100	100	100	15
440/460V	[kA]	100	100	100	100	100	100	100	100	100	10	6
500V	[kA]	100	100	100	100	100	100	100	100	100	10	6
690V	[kA]	100	100	100	100	100	8	6	6	4	4	3

(1) No back-up fuse required.

		Cat.No.140M-D8T-		Cat.No.140M-F8T-	
		C16	C20	C25	C32
Rated Operational Current, I_e	[A]	16	20	25	32
Magnetic Release Current	[A]	260	325	416	585
Switching of Standard Three-Phase Motors, AC-3					
230/240V ⁽¹⁾	[kW]	4.0	5.5	6.3	7.5
400/415V ⁽¹⁾	[kW]	7.5	10	11	15
500V ⁽¹⁾	[kW]	10	11	15	20
690V ⁽¹⁾	[kW]	13	17	22	30
Back-Up Fuses gG, gL, only if $I_{cc} \geq I_{cu}$					
230/240V	[A]	(2)	(2)	(2)	(2)
400/415V	[A]	80	100	100	125
440/460V	[A]	80	100	100	125
500V	[A]	80	80	100	125
690V	[A]	63	63	80	100
Ultimate Short Circuit Breaking Capacity, I_{cu}					
230/240V	[kA]	100	100	100	100
400/415V	[kA]	100	65	65	65
440/460V	[kA]	50	25	65	65
500V	[kA]	50	25	50	50
690V	[kA]	6	6	10	10
Rated Service Short Circuit Breaking Capacity, I_{cs}					
230/240V	[kA]	100	100	100	100
400/415V	[kA]	25	25	50	50
440/460V	[kA]	25	25	50	50
500V	[kA]	25	25	50	50
690V	[kA]	4	4	6	6

(1) Consult your local Rockwell Automation sales office or Allen-Bradley distributor.

(2) No back-up fuse required.

General Data

Cat.No.		140M-C	140M-D	140M-F
Rated Insulation Voltage U_i				
IEC, SEV, VDE0660	[V]		690	
UL, CSA	[V]		600	
Rated Impulse Withstand Voltage U_{imp}				
Pollution degree			3	
Main circuits U_{imp} /Overvoltage Category			6kV/III	
Auxiliary circuits U_{imp} /Overvoltage Category			6kV/III	
Rated Frequency	[Hz]		50/60	
Utilization Category				
IEC60947-2 (Circuit breaker)			A	
IEC60947-4-1 (Motor starter)			AC-3	
Lifespan				
Mechanical	[operations]	100000		30000
Electrical (I_e max.)	[operations]	100000		30000
Switching Frequency	[operations/h]		max.25	
Ambient Temperature				
Storage	[°C]		-40...+80	
Operation	[°C]		-25...+60	



Cat.No.		140M-C	140M-D	140M-F
Climatic resistance				
Moisture change climate (60068-2-30)		23°C/83% relative humidity and 40°C/92% relative humidity, 56 cycles		
Dry heat (60086-2-2)		100°C, relative humidity <50%, 7 days		
Moisture heat (60068-2-3)		40°C, relative humidity 93%, 56 days		
Site Altitude	[m]	to 2000 N.N.		
Protection Class		140M-C; 140M-D : IP2X from all directions 140M-F : IP2X from front with front (upper) terminal wired		
Resistance to Shock, Transport (60068-2-27)		30 g, 11 ms, all axes		
Resistance to Vibration, Operation (60068-2-6)		5g		
Rated Thermal Current I_{th}				
up to 40°C ambient temperature	[A]	0.1...32	1.6...32 (1.0...32 for -D8V)	6.3...45
up to 60°C ambient temperature	[A]	0.1...32	1.6...32 (1.0...32 for -D8V)	6.3...45
Rated Supply Current I_e	[A]	0.1...32	1.6...32 (1.0...32 for -D8V)	6.3...45
Dependence on Temperature				
40°C	[A]	no reduction		
50°C	[A]	no reduction		
60°C	[A]	no reduction		
70°C	[A]	15% current reduction of the upper rated current I_e		
Overload Protection				
Characteristics		IEC 60947-4-1 Motor protection (except Cat.Nos.140M-C2N,140M-D8N,140M-F8N)		
Ambient Temperature Compensation	[°C]	-20...+60		
Phase-loss Protection		Differential release		
Trip class		10 (except Cat.Nos.140M-C2N,140M-D8N,140M-F8N) fixed setting		
Magnetic Release current ($\pm 20\%$)		fixed setting 13...14 x I_e max. (for 140M-C2E,140M-D8E,140M-F8E,140M-C2N,140M-D8N,140M-F8N) 16...21 x I_e max. (for 140M-C2T,140M-D8T,140M-F8T) I_e max. = maximum values of setting ranges fixed magnetic setting for 140M-D8V; see ratings		
Total Power Loss P_v				
Circuit Breaker at rated load operating temperature	[W]	6...11.5	6...11.6	9...16
Main Disconnect Switch Application		Yes, with accessories		
Application Conditions		For utilization outside North America, assemblies (of products) shall comply to the IEC61439-1 requirements 140M manual motor starters are intended for use in closed areas without hazardous operating conditions such as dust or explosive or corrosive gases. Enclosures of appropriate manner need to be in place to protect devices in such environments.		
Application Conditions (140M-D8V)		PWM frequency ≤ 4 kHz VFD output frequency 0...400 Hz Maximum cable length that is listed in the drive instruction manual applies. Adding a common mode core and utilizing XLPE cable helps minimize cable charging current.		



Cat.No.			140M-C...	140M-D...	140M-F...
Conformity to Standards			IEC60947-1;-2;-4-1; EN60947-1;-2;-4-1; UL508; CSA22.2, No.14		
Approvals			CE,UL,CSA		
Terminal Parts Type of terminals					
Screwdriver			PozidrivNo.2/BladeNo.3		PozidrivNo.2/BladeNo.3
	1.conductor	[mm ²]/[AWG]	1...6/No.16...10		2.5...25/No.14...4
	2.conductor	[mm ²]/[AWG]	1...4/No.16...10		2.5...25/No.14...4
	1.conductor	[mm ²]/[AWG]	1...6/No.16...10		2.5...25/No.14...4
	2.conductor	[mm ²]/[AWG]	1...6/No.16...10		2.5...25/No.14...4
	1.conductor	[mm ²]/[AWG]	1.5...6/No.16...8		16...25/No.14...4
	2.conductor	[mm ²]/[AWG]	1.5...6/No.16...8		16...25/No.14...4
	1.conductor	[mm ²]/[AWG]	1...6/No.16...10		2.5...10/No.14...8
	2.conductor	[mm ²]/[AWG]	1...6/No.16...10		2.5...10/No.14...8
Tightening torque			2...2.5/18...22		3...3.5/27...30

Cat.No.			140M-RC...
Terminal Parts Type of terminals			
Screwdriver			
	1.conductor	[mm ²]/[AWG]	0.5...2.5/—
	2.conductor	[mm ²]/[AWG]	0.5...2.5/—
	1.conductor	[mm ²]/[AWG]	0.5...2.5/No.18...12
	2.conductor	[mm ²]/[AWG]	0.5...2.5/No.18...12
	1.conductor	[mm ²]/[AWG]	1...4/No.16...12
	2.conductor	[mm ²]/[AWG]	1...4/No.16...12

Accessories for Bulletin 140M Motor Protection Circuit Breakers



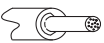

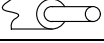
		Auxiliary Contact Blocks for Front Mounting Cat.No.140M-C-AFA...,140M-C-AFAR...			Auxiliary Contact Blocks for Right-Side Mounting Cat.No.140M-C-ASA...,140M-C-ASAR...					
Rated Thermal Current I_{th} at 40°C ambient temperature	[A]	5			10					
	[A]	4			6					
Contact Class Coordination According to NEMA										
(UL/CSA Standards)	AC	B300			B600					
	DC	Q300			Q600					
Back-Up Fuses gG, gL	[A]	10			10					
Rated Supply Current	[V]	24	120	240	24	120	240	415	690	
	AC-15	[A]	4	3	1.5	6	5	3	2	0.7
	DC-13	[V]	24	120	240	24	120	240	415	
	[A]	2	0.5	0.25	2	0.5	0.25	0.15		
Terminal Parts Type of terminals										
Screwdriver		PozidrivNo.2/BladeNo.3								
	1.conductor	[mm ²]/[AWG]	0.5...1.5/18...14			0.5...2.5/18...14				
	2.conductor	[mm ²]/[AWG]	0.75...1.5/18...14			0.75...2.5/18...14				

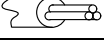
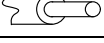
			Auxiliary Contact Blocks for Front Mounting Cat.No.140M-C-AFA...,140M-C-AFAR...	Auxiliary Contact Blocks for Right-Side Mounting Cat.No.140M-C-ASA...,140M-C-ASAR...
	1.conductor	[mm ²]/[AWG]	0.75...1.5/18...14	0.75...2.5/18...14
	2.conductor	[mm ²]/[AWG]	0.75...1.5/18...14	0.75...2.5/18...14
	1.conductor	[mm ²]/[AWG]	0.75...1.5/18...14	0.75...2.5/18...14
	2.conductor	[mm ²]/[AWG]	0.75...1.5/18...14	0.75...2.5/18...14
Tightening torque		[N·m]/[lb·in]	1.2...1.5/10.6...13	1.2...1.5/10.6...13

		Undervoltage Trip for Left-Side Mounting Cat.No.140M-C-UX...	Undervoltage Trip with 2 Auxiliary Contacts for Left-Side Mounting Cat.No.140M-C-UC...	Shunt Trip for Left-Side Mounting Cat.No.140M-C-SN...
Actuating Voltage				
Pull-in		0.85...1.1 x U _s	0.85...1.1 x U _s	0.7...1.1 x U _s
Drop-out		0.7...0.35 x U _s	0.7...0.35 x U _s	
Rated Control Voltage	min. max.	21V 50 Hz, 24V 60 Hz 600V 50 Hz	21V 50 Hz, 24V 60 Hz 600V 50 Hz	21V 50 Hz, 24V 60 Hz 600V 50 Hz
On-Time		100%	100%	AC: 100%; DC: max. 5 sec.
Coil Rating	Pull-in Hold	8.5VA, 8 W 4VA, 2 W	8.5VA, 8 W 4VA, 2 W	8.5VA, 8 W 4VA, 2 W
Terminal Parts Type of terminals				
Screwdriver		PozidrivNo.2/BladeNo.3		
	1.conductor	[mm ²]/[AWG]	0.5...2.5/No.18...14	
	2.conductor	[mm ²]/[AWG]	0.75...2.5/No.18...14	
	1.conductor	[mm ²]/[AWG]	0.75...2.5/No.18...14	
	2.conductor	[mm ²]/[AWG]	0.75...2.5/No.18...14	
	1.conductor	[mm ²]/[AWG]	0.75...2.5/No.18...14	
	2.conductor	[mm ²]/[AWG]	0.75...2.5/No.18...14	
Tightening torque		[N·m]/[lb·in]	1.2...1.5/10.6...13.3	

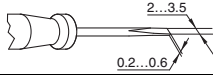
		Compact Busbar Feeder Terminal		Compact Busbar		Compact Busbar Feeder Block				
		140M-C-WTN 140M-C-WTEN	140M-F-WTE	140M-C -W...	140M-F -W...	140M-C- WBEL1,L2,L3	140M-C- WBET1,T2,T3	140M-F- WBEL1,L2,L3	140M-F- WBET1,T2,T3	
Rated Thermal Current I _{th} at 60°C ambient temperature		[A]	64	120	64	120	64	IEC120/UL115		
	1.conductor	[mm ²]/[AWG]	2.5...25/14...4	—	—	—	4...25/10...4	for use with 140M-C-W	4...50/10...4	for use with 140M-F-W
	1.conductor	[mm ²]/[AWG]	2.5...25/14...4	4...50/12...1/0	—	—	4...25/10...4	for use with 140M-C-W	4...25/10...4	for use with 140M-F-W
	1.conductor	[mm ²]/[AWG]	2.5...25/14...4	2.5...50/ 12...1/0	—	—	2.5...25/ 14...4	for use with 140M-C-W	2.5...25/ 14...4	for use with 140M-F-W
Tightening torque		[N·m]/[lb·in]	3...3.5/27...31	5...6/45...54	—	—	3...3.5/ 27...31	2.5...3/ 23...27	5...6/45...54	

Accessories for Bulletin 140M Screwless

Cat.No.		140M-RC...	
Terminal Parts Type of terminals			
Screwdriver			
	1.conductor 2.conductor	[mm ²]/[AWG] [mm ²]/[AWG]	0.5...1.5/— 0.5...1.5/—
	1.conductor 2.conductor	[mm ²]/[AWG] [mm ²]/[AWG]	0.5...1.5/No.18...14 0.5...1.5/No.18...14
	1.conductor 2.conductor	[mm ²]/[AWG] [mm ²]/[AWG]	0.5...1.5/No.18...14 0.5...1.5/No.18...14

Weights

Description	Weight [g]	Cat.No.	Description	Weight [g]	Cat.No.	
Motor Protection Circuit Breakers	317	140MC-C2E-...	Anti-Tamper Cover	2	140M-C-CA	
	373	140M-D8E-...	Lockable Twist Knob	5	140M-C-KN1	
	782	140MC-F8E-...			140M-C-KRY1	
	315	140M-C2N-...	Locking Tag	30	140M-C-M3	
	365	140M-D8N-...	Door Coupling Handle	123	140M-C-DN66	
	782	140M-F8N-...			140M-C-NRY66	
	315	140M-C2T-...	Extension Shaft	46	140M-C-DS	
	365	140M-D8T-...	Legend Plate	4	140M-C-DFC...	
	782	140M-F8T-...	Feeder Terminal	51	140M-C-WTEN	
Auxiliary Contacts	10	140M-C-AFA10			Compact Busbars	172
		140M-C-AFA01	27	140M-C-W452N		
		140M-C-AFA11	48	140M-C-W453N		
		140M-C-AFA20	69	140M-C-W454N		
		140M-C-ASA...	90	140M-C-W455N		
	15	140M-C-AFAR10A...	30	140M-C-W542N		
		140M-C-ASAR...M...	55	140M-C-W543N		
140M-C-ASAM11		80	140M-C-W544N			
Undervoltage Trip	108	140M-C-UX...	105	140M-C-W545N		
	110	140M-C-SN...	Top Hat Rail Adapter	6	140-KBH2	
	116	140M-C-UC...				

Cutoff Current

The Bulletin 140-M limits solid short-circuit current I_{cc} (prospective short-circuit current). I_D is the maximum cutoff current (highest instantaneous value of the limited short-circuit current). This value is indicated in the following diagrams as a function of the progressive system short-circuit current.

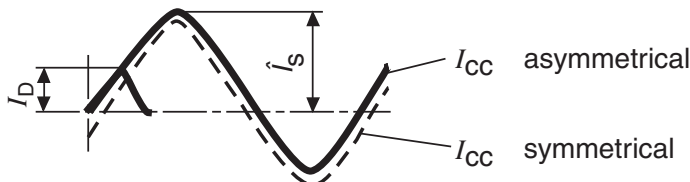

Bulletin140M-C Circuit Breaker (Maximum Cutoff Current)

140M-C2E, -C2N, -C2T
Max. Cut-Off Current, $U_e = 400...415V$

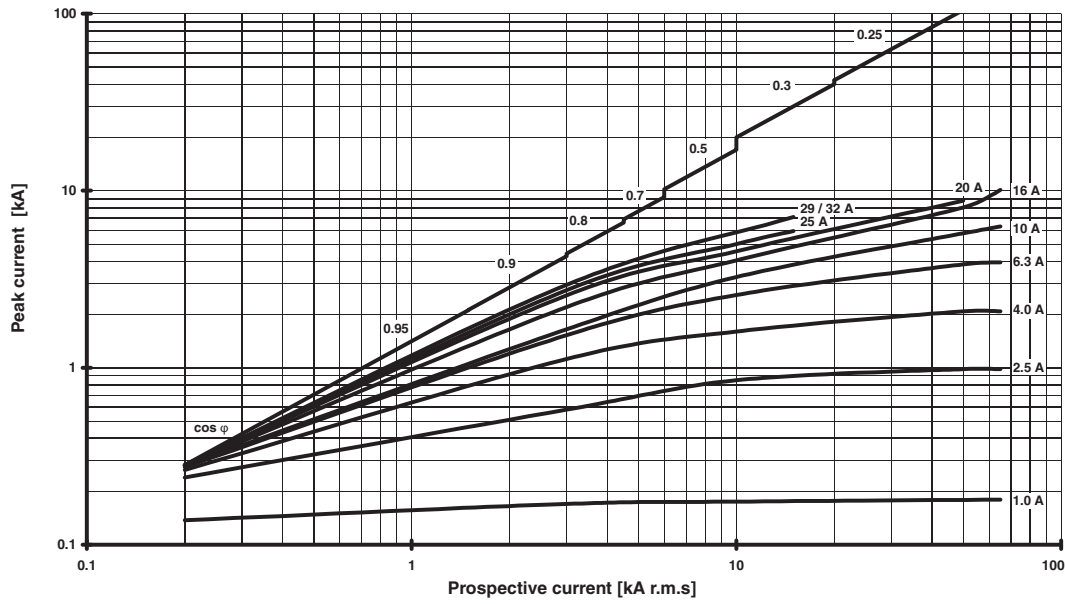

Bulletin140M-D8E, -D8N, D8T Circuit Breaker (Maximum Cutoff Current)

140M-D8E, -D8N, -D8T
Max. Cut-Off Current, $U_e = 400...415V$

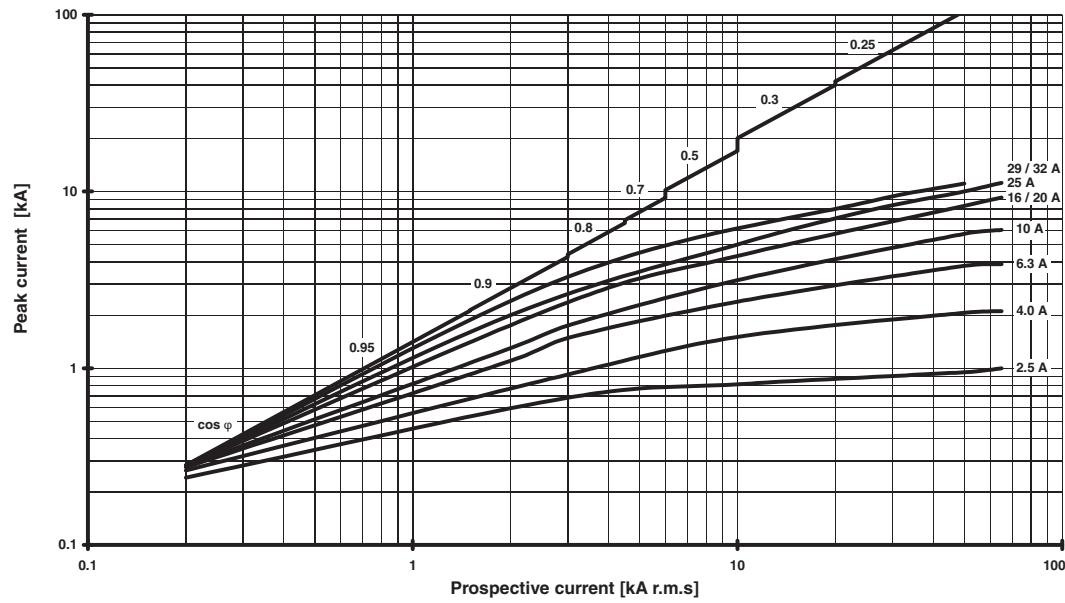

Bulletin140M-D8V Circuit Breaker (Maximum Cutoff Current)

140M-D8V
 Max. Cut-Off Current, $U_e = 400...415V$

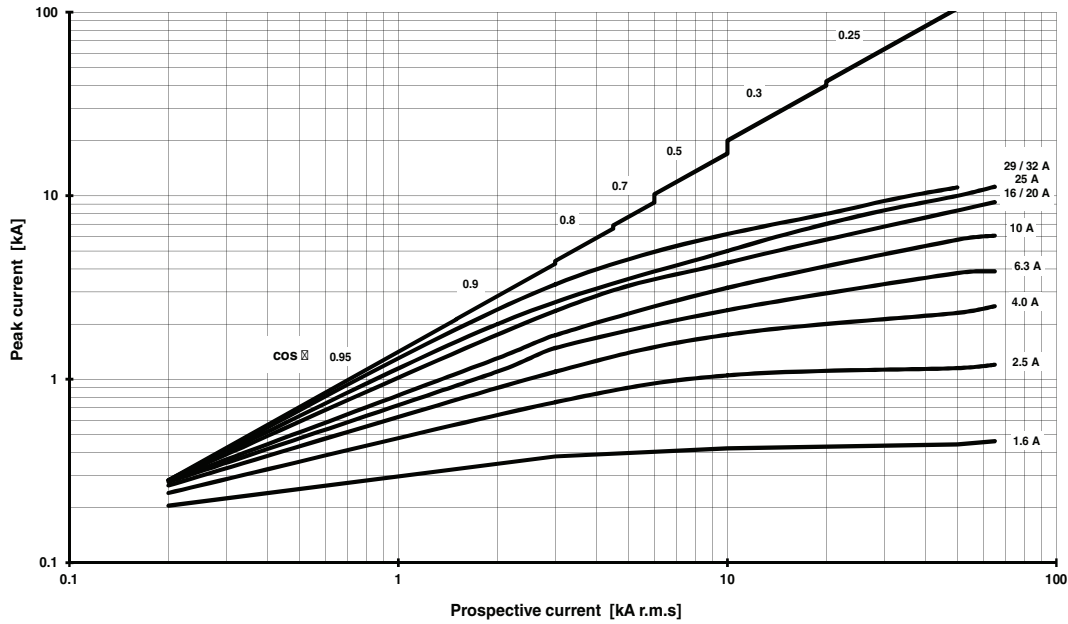

Bulletin140M-F Circuit Breaker (Maximum Cutoff Current)

140M-F8E, -F8N, -F8T
 Max. Cut-Off Current, $U_e = 400...415V$

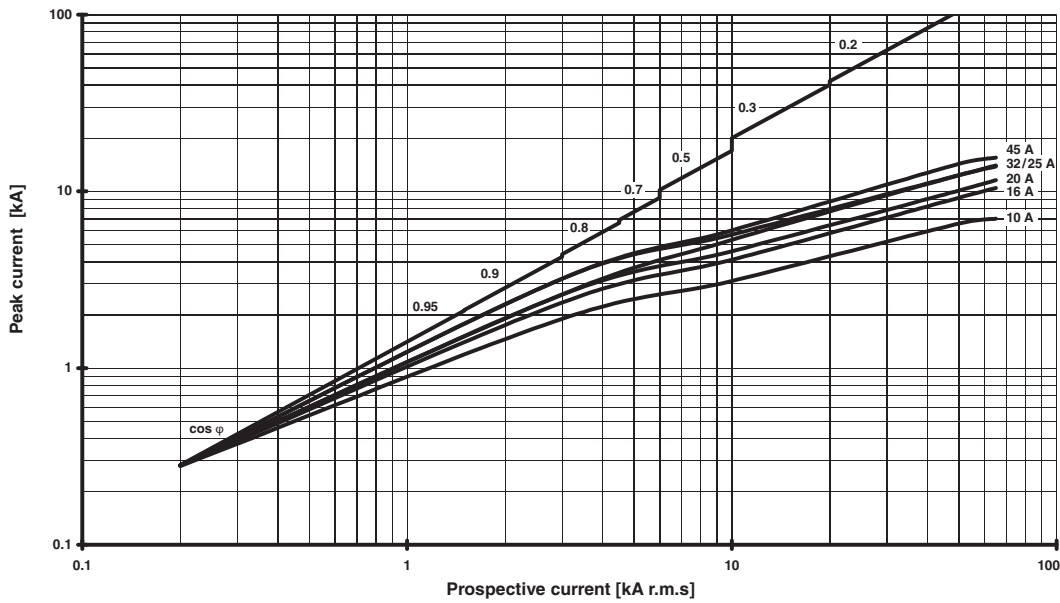

Bulletin140M-C Circuit Breaker (Maximum Let-through Energy)

140M-C2E, -C2N, -C2T
 Max. Let-Through-Energy, $U_0 = 400...415V$

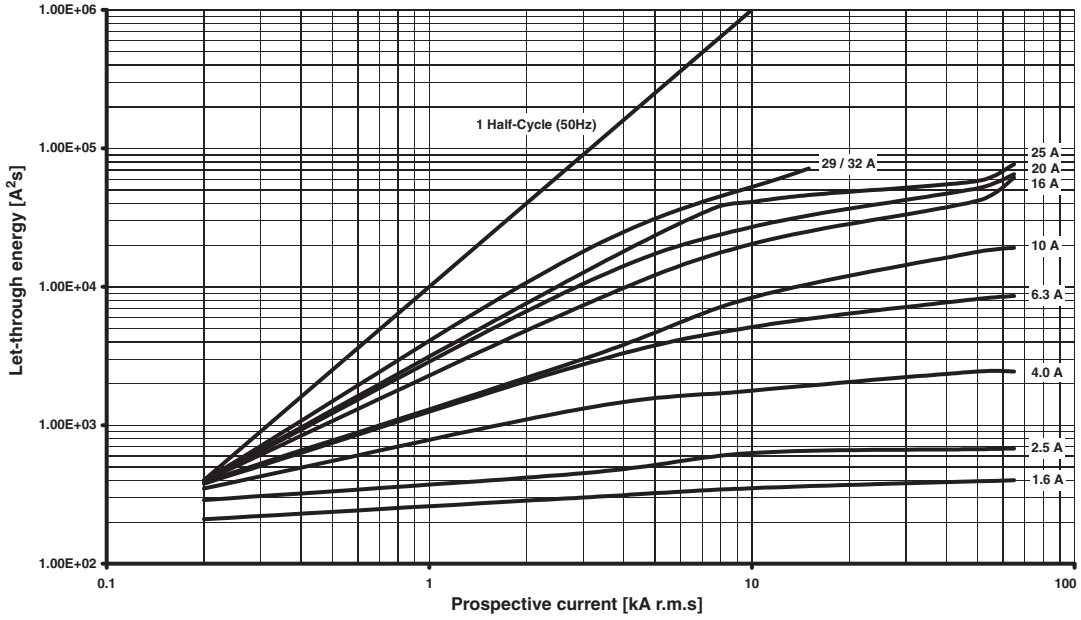

Bulletin140M-D8E, -D8N, -D8T Circuit Breaker (Maximum Let-through Energy)

140M-D8E, -D8N, -D8T
 Max. Let-Through-Energy, $U_0 = 400...415V$

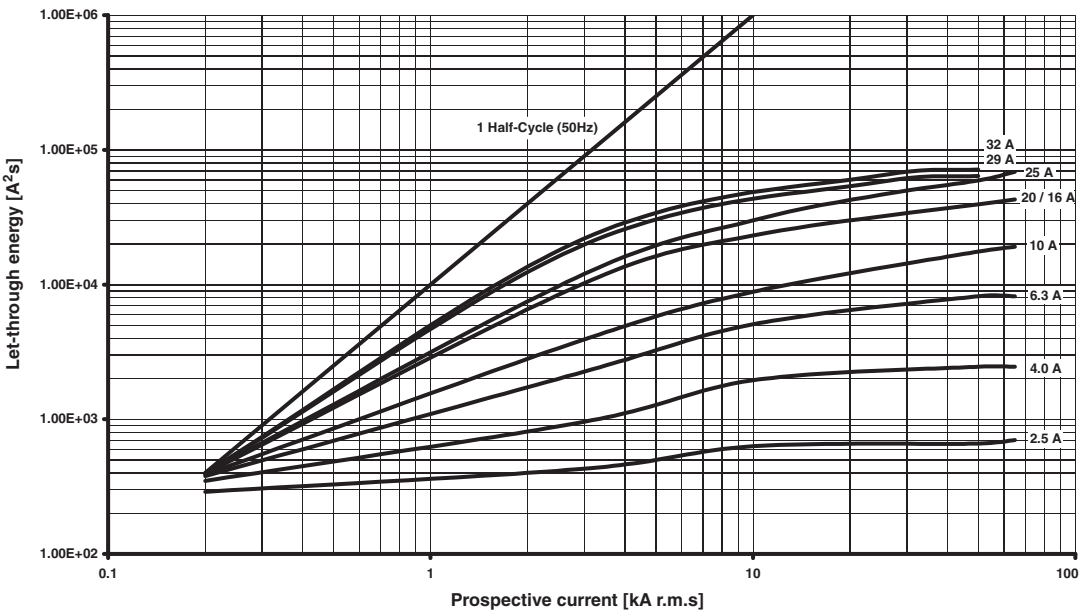

Bulletin140M-D8V Circuit Breaker (Maximum Let-through Energy)

140M-D8V
 Max. Let-Through-Energy, $U_e = 400... 415V$

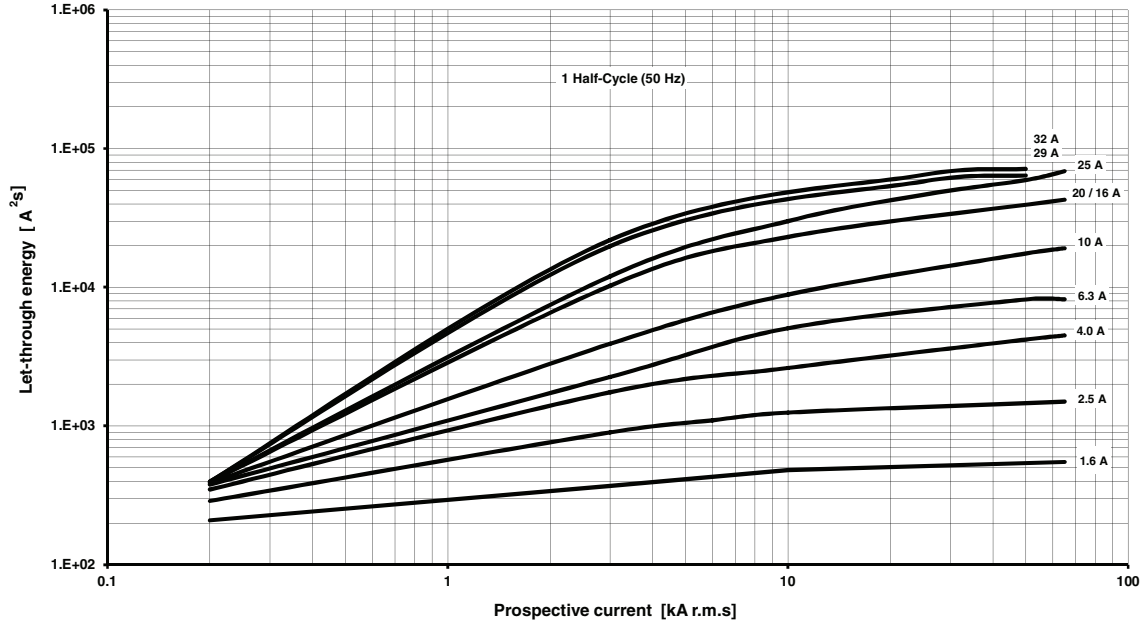

Bulletin140M-F Circuit Breaker (Maximum Let-through Energy)

140M-F8E, -F8N, -F8T
 Max. Let-Through-Energy, $U_e = 400...415V$

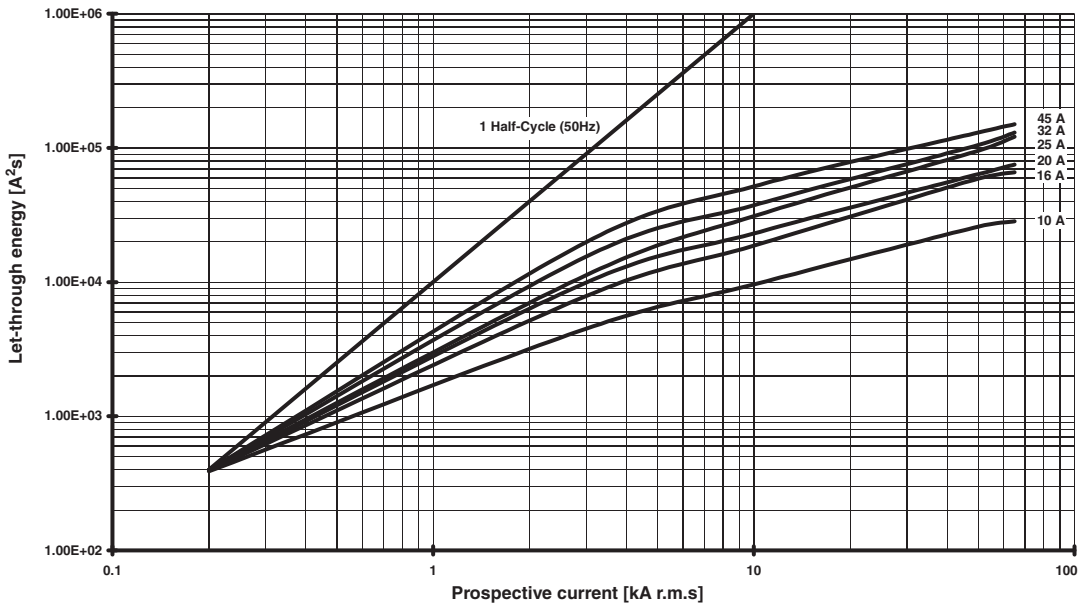

Time-Current Characteristic

Motor Protection Circuit Breakers Time-Current Characteristic

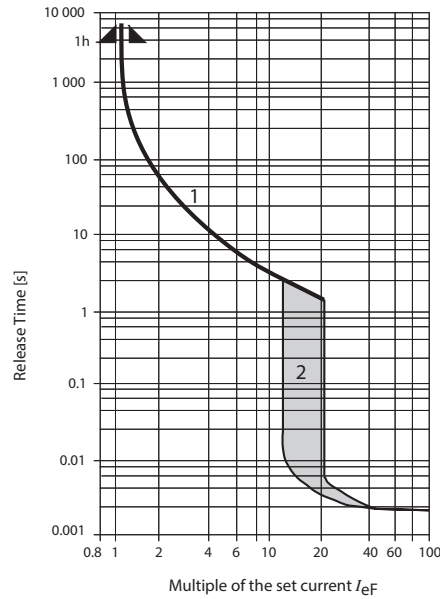

140M-C, -D, -F Motor Protection Circuit Breakers (for 140M-D8V, see ratings)

Thermal Release Trip Current

The adjustable current-dependent delayed bimetal release protects motors against overload. The curve shows the mean operating current at an ambient temperature of 20 °C starting from the cold state. Careful testing and setting ensures effective motor protection even in the case of single phasing. The overload characteristic is also valid for transformer protection.

Magnetic Release Trip Current

The instantaneous magnetic trip has a fixed operating current setting. This corresponds to 13...14 times the maximum value of setting range. (Transformer protection up to 20 x I_c max.) At a lower setting it is correspondingly higher.

Current Setting I_cF

The overload trip corresponds to a thermal overload relay in a motor starter conforming to IEC947-4-1. If a different value is prescribed (e.g., reduced I_c for cooling medium having a temperature higher than 40 °C or a place of installation higher than 2000 m above sea level), the setting current is equal to the reduced rated current I_c of the motor.

Notes:

Approximate Dimensions

Dimensions are shown in millimeters (inches). Dimensions are not intended to be used for manufacturing purposes.

Cat. No. 140M-C, -D

Cat. No. 140M-C2...

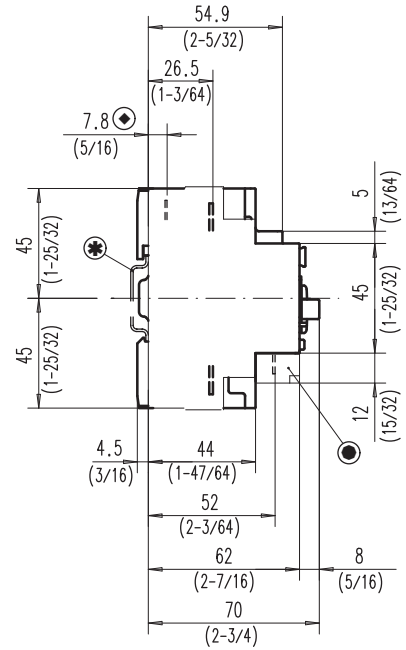
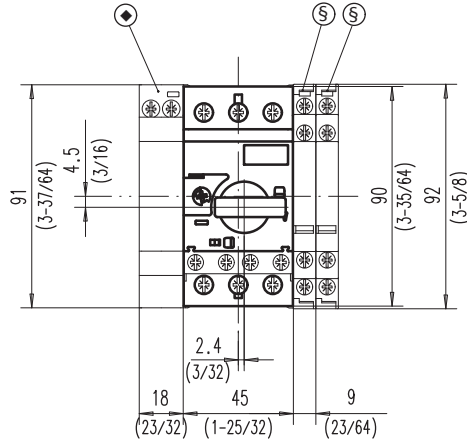
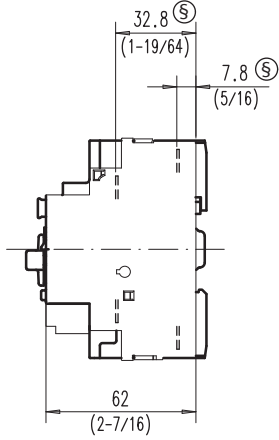

Cat. No. 140M-D8...

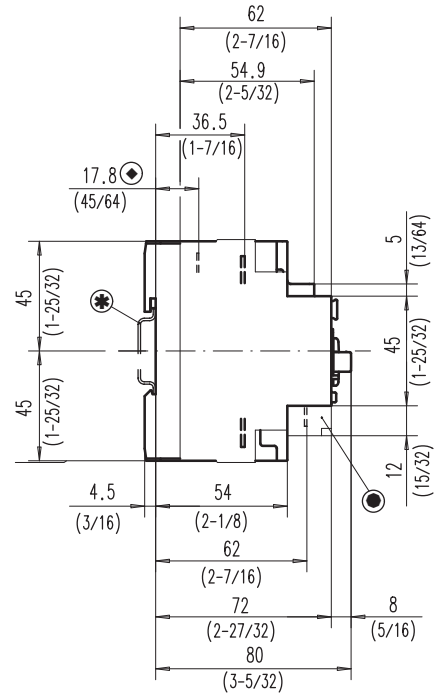
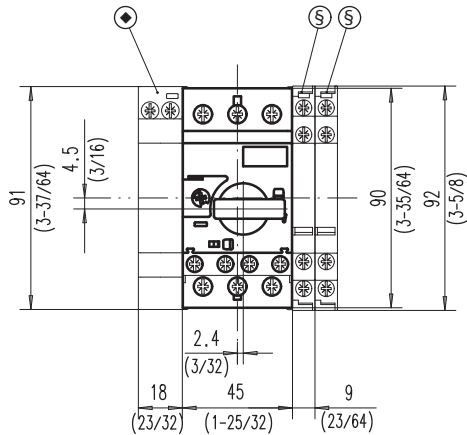
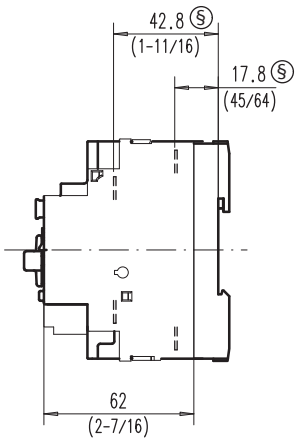

- * Mounting on 35 mm DIN Rail
- ◆ Undervoltage/shunt trip
- Auxiliary contact (front mounted)
- § Auxiliary contact (side mounted)

Cat. No. 140M-F

Cat. No. 140M-F8...

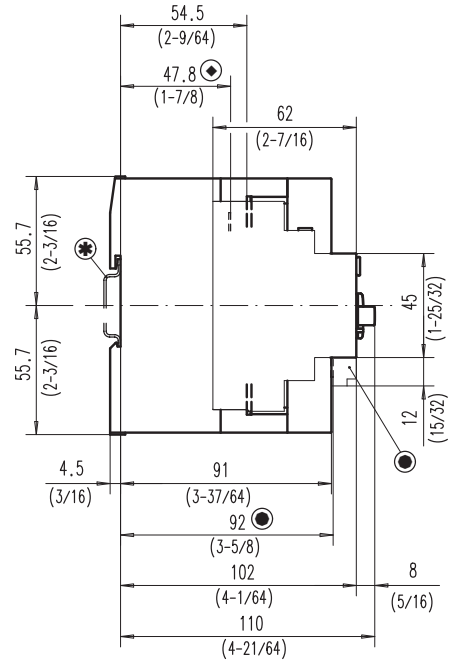
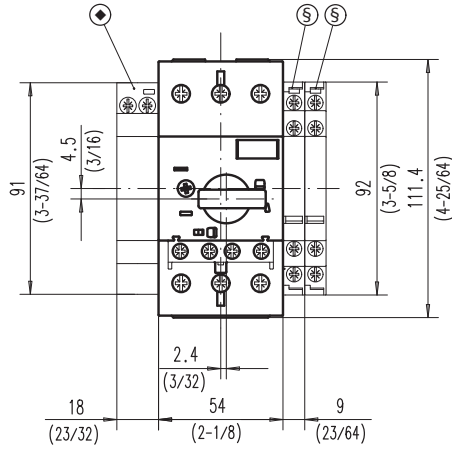
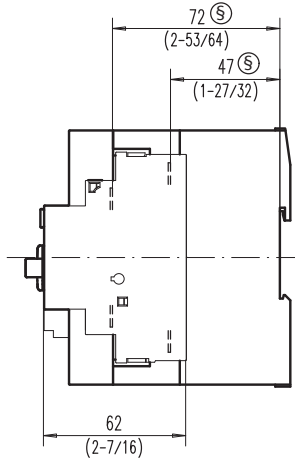

- * Mounting on 35 mm DIN rail
- ◆ Undervoltage/shunt trip
- Auxiliary contact (front mounted)
- § Auxiliary contact (side mounted)

Cat. No. 140M-RC, Screwless

Cat. No. 140M-RC...

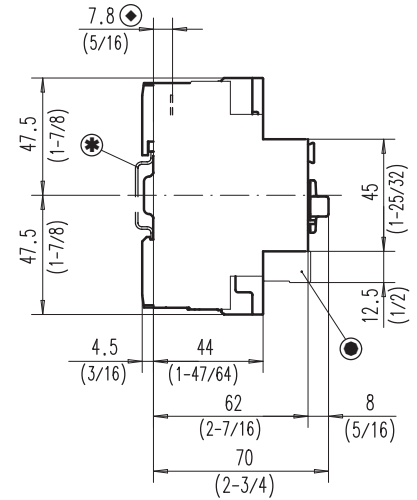
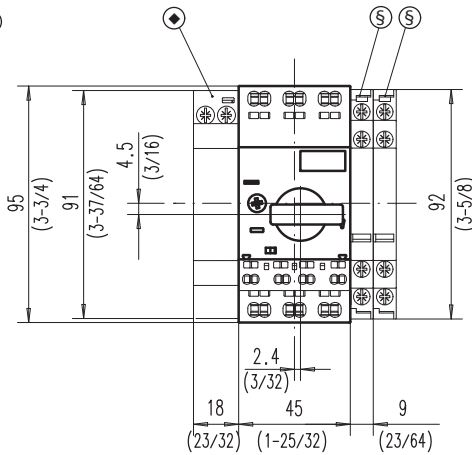
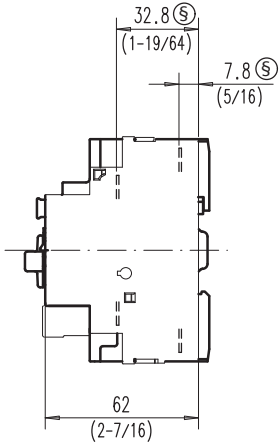

- * Mounting on 35 mm DIN rail
- ◆ Undervoltage/shunt trip
- Auxiliary contact (front mounted)
- § Auxiliary contact (side mounted)

Mounting position/safety clearance of Cat. No. 140M-C..., 140M-D..., 140M-F...

Cat. No. 140M-C/D...

Cat. No. 140M-F...

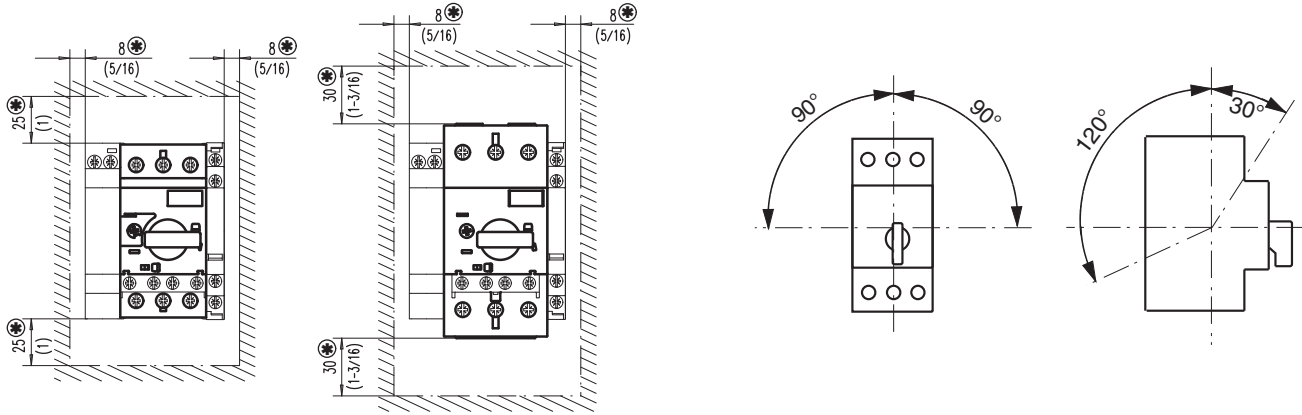

* Minimum distance to grounded parts or walls

Cat. No. 140M-C-TE1 Type E adapter on Cat. No. 140M-C2E...

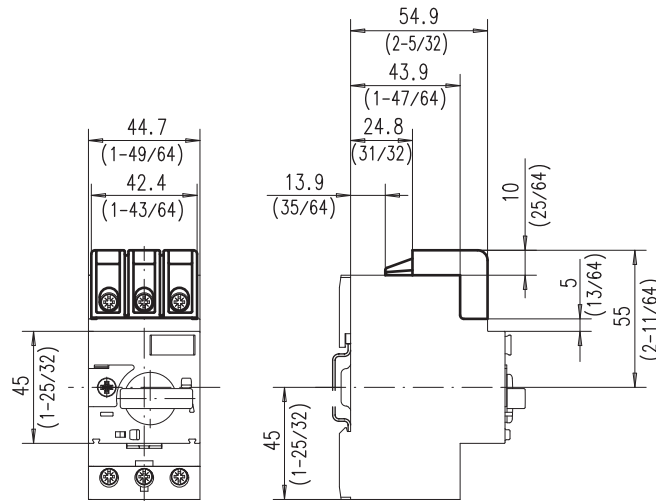

Cat. No. 140M-C-TE1 Type E adapter on Cat. No. 140M-D8E...

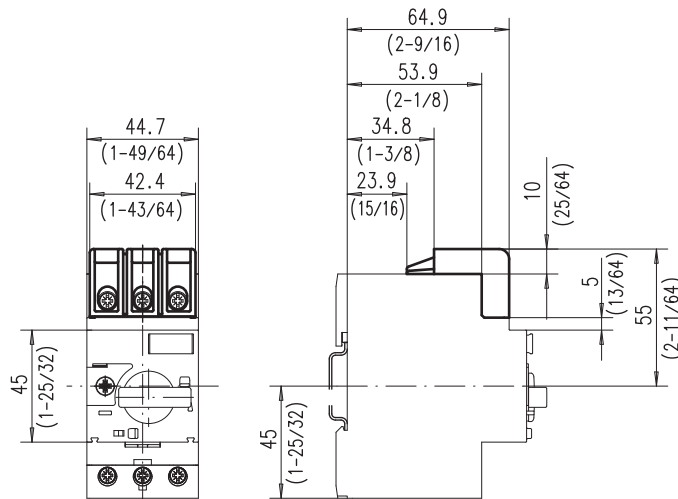

Cat. No. 140M-C-TE1 Type E adapter on Cat. No. 140M-F8E...

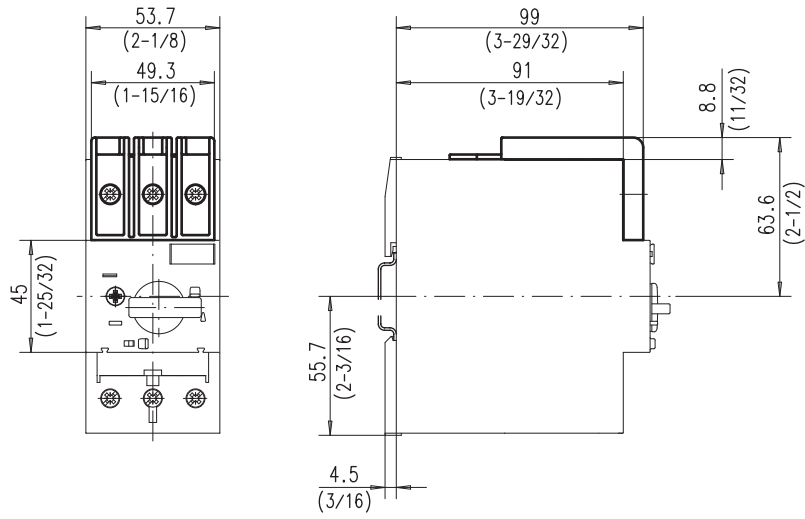

Screw Adapter 140M-C-N45 for 140M-C2/D8 and 140M-F8

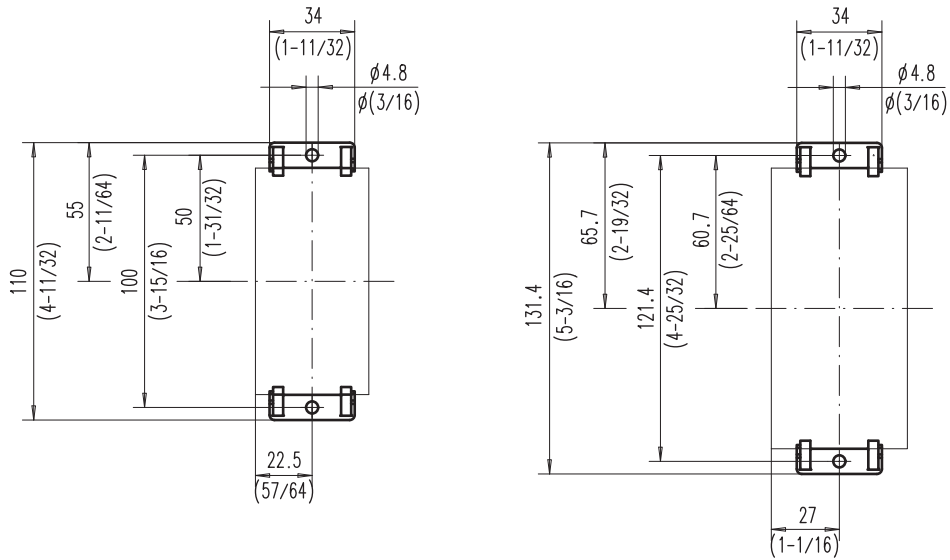

Cat. No. 140M-C with Busbar

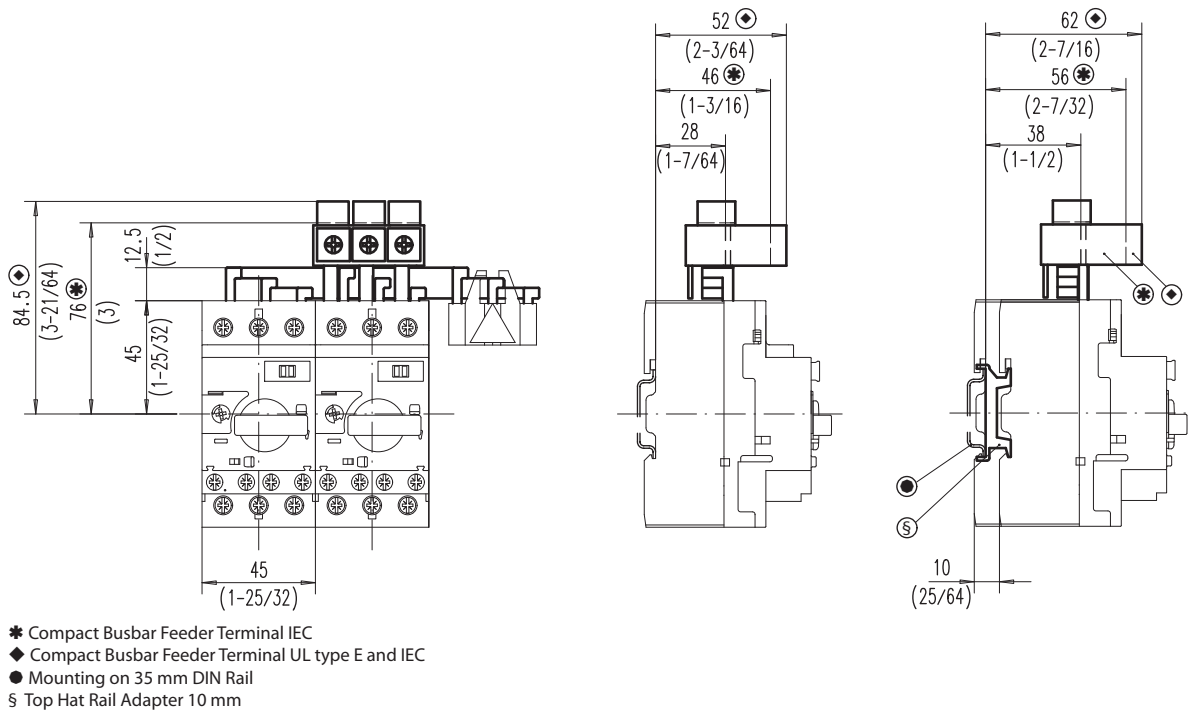

140M-C-SHS Screw Adapter

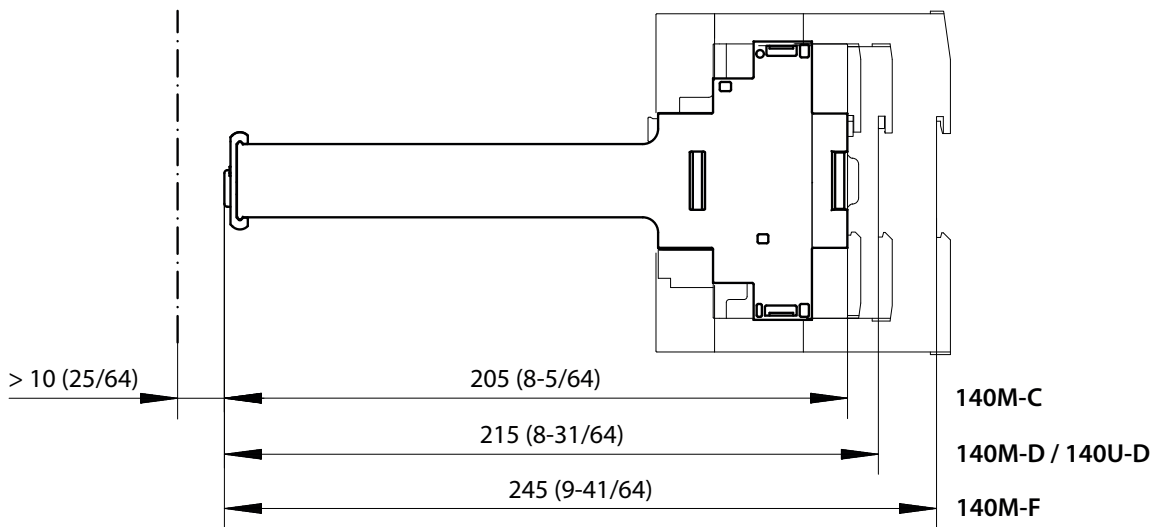

140M-C-D...66

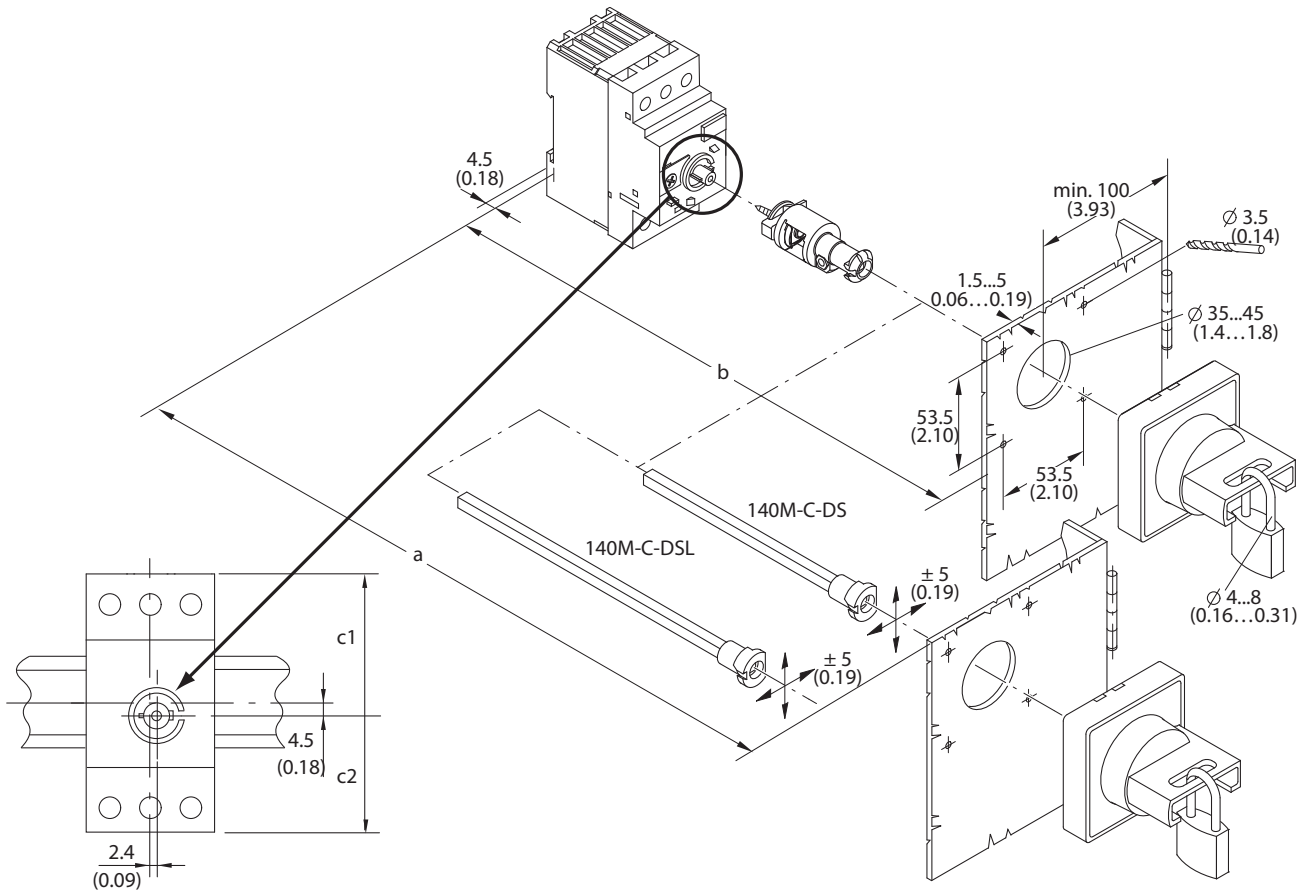

Cat. No.	With Cat. No. 140-M-C-DS Shaft				With Cat. No. 140-M-C-DSL Shaft			
	a	b	c1	c2	a	b	c1	c2
140M-C	117...338 (4.6...13.3)	105.5 ±5 (4.15 ±0.19)	49.5 (1.95)	40.5 (1.6)	117...438 (4.6...17.2)	105.5 ±5 (4.15 ±0.19)	49.5 (1.95)	40.5 (1.6)
140M-D	126...347 (4.96...13.66)	114.5 ±5 (4.5 ±0.19)	49.5 (1.95)	40.5 (1.6)	126...497 (4.96...19.56)	114.5 ±5 (4.5 ±0.19)	49.5 (1.95)	40.5 (1.6)
140M-F	148.6...369.6 (5.85...14.55)	137.1 ±5 (5.39 ±0.19)	59.35 (2.34)	50.35 (1.98)	148.6...519 (5.85...20.43)	137.1 ±5 (5.39 ±0.19)	59.35 (2.34)	50.35 (1.98)

140M-C-WBE

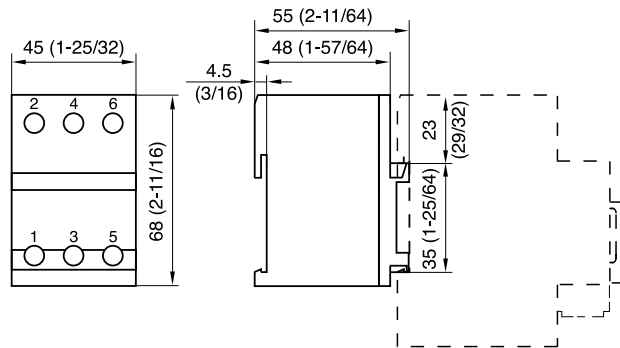

Cat. No. 198E...

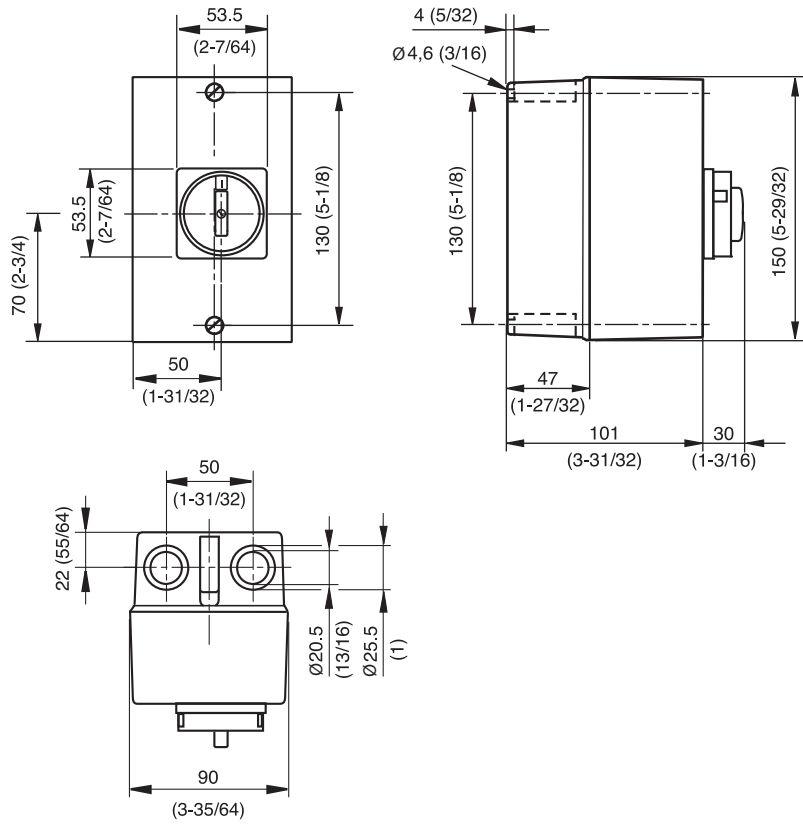

Notes:

Rockwell Automation Support

Use the following resources to access support information.

Technical Support Center	Knowledgebase Articles, How-to Videos, FAQs, Chat, User Forums, and Product Notification Updates.	www.rockwellautomation.com/knowledgebase
Local Technical Support Phone Numbers	Locate the phone number for your country.	www.rockwellautomation.com/global/support/get-support-now.page
Direct Dial Codes	Find the Direct Dial Code for your product. Use the code to route your call directly to a technical support engineer.	www.rockwellautomation.com/global/support/direct-dial.page
Literature Library	Installation Instructions, Manuals, Brochures, and Technical Data.	www.rockwellautomation.com/literature
Product Compatibility and Download Center (PCDC)	Get help determining how products interact, check features and capabilities, and find associated firmware.	www.rockwellautomation.com/global/support/pcdc.page

Documentation Feedback

Your comments will help us serve your documentation needs better. If you have any suggestions on how to improve this document, complete the How Are We Doing? form at http://literature.rockwellautomation.com/idc/groups/literature/documents/du/ra-du002_-en-e.pdf.

Rockwell Automation maintains current product environmental information on its website at <http://www.rockwellautomation.com/rockwellautomation/about-us/sustainability-ethics/product-environmental-compliance.page>.

Allen-Bradley, LISTEN. THINK. SOLVE, Rockwell Automation, and Rockwell Software are trademarks of Rockwell Automation, Inc. Trademarks not belonging to Rockwell Automation are property of their respective companies.

Rockwell Otomasyon Ticaret A.Ş., Kar Plaza İş Merkezi E Blok Kat:6 34752 İçerenköy, İstanbul, Tel: +90 (216) 5698400

www.rockwellautomation.com

Power, Control and Information Solutions Headquarters

Americas: Rockwell Automation, 1201 South Second Street, Milwaukee, WI 53204-2496 USA, Tel: (1) 414.382.2000, Fax: (1) 414.382.4444
Europe/Middle East/Africa: Rockwell Automation NV, Pegasus Park, De Kleetlaan 12a, 1831 Diegem, Belgium, Tel: (32) 2 663 0600, Fax: (32) 2 663 0640
Asia Pacific: Rockwell Automation, Level 14, Core F, Cyberport 3, 100 Cyberport Road, Hong Kong, Tel: (852) 2887 4788, Fax: (852) 2508 1846

Publication 140M-TD002G-EN-P - January 2018

Supersedes Publication 140M-TD002F-EN-P September 2016

Copyright © 2018 Rockwell Automation, Inc. All rights reserved. Printed in the U.S.A.